

# ONKYO

# TX-RZ900/TX-RZ800

## AV RECEIVER

## Basic Manual

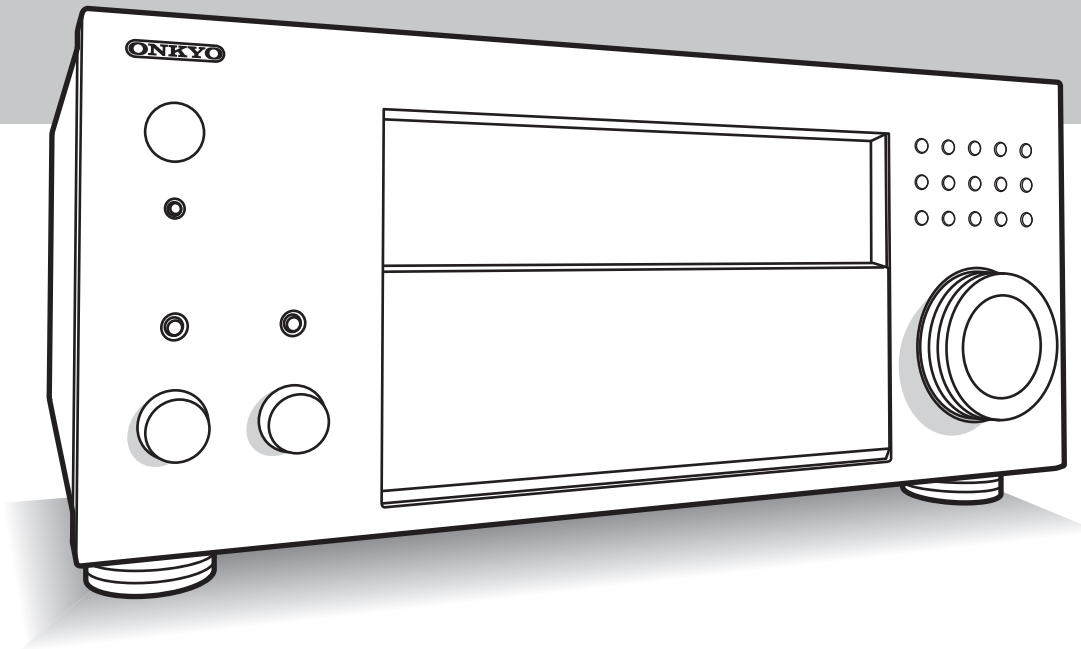

This manual includes information needed when starting up and also instructions for frequently used operations. The Advanced Manual is published on the web for ecological reasons and has more detailed information and advanced settings.

Advanced Manual  
found here



<http://www.onkyo.com/manual/trz900800/adv/en.html>



# Features

## TX-RZ900/TX-RZ800:

- Equipped with 7 ch amplifier
- Supports playback in Dolby Atmos format and has Dolby Surround listening mode
- Supports playback in DTS:X format and has DTS Neural:X listening mode
- THX Select2 Plus certified
- Equipped with 4K compatible HDMI IN/OUT jacks
- Equipped with 2 HDMI output jacks
- Supports the HDMI Standby Through function which allows transmission from players to the TV in standby state
- Supports HDCP2.2 (supported by HDMI IN1 to IN5/ HDMI OUT MAIN/SUB)
- Supports ARC (Audio Return Channel)
- Supports variety of network functions such as Internet Radio, DLNA, AirPlay, etc.
- Supports Wi-Fi and BLUETOOTH®
- Bi-Amping capability
- A/V Sync Function to correct deviation of audio and video
- Multi-zone function (Zone 2 and Zone 3) which allows you to play something in the main room while enjoying a different source in a separate room (Video and audio can also be output to Zone 2 through HDMI)
- Music Optimizer™ for compressed digital music files
- Phase Matching Bass System
- Automatic speaker setup available using supplied calibrated microphone (AccuEQ Room Calibration)
- Supports playback of MP3, WMA, WMA Lossless, FLAC, WAV, Ogg Vorbis, Apple Lossless, DSD, Dolby TrueHD via network and USB storage device (the supported formats will differ depending on the use environment)

## TX-RZ900:

- The two front channels have parallel push-pull circuits for reproducing powerful bass
- Equipped with a high-class toroidal transformer as an independent power source for the audio circuitry

# Contents

## Basic Manual (this document)

Front Panel.....	3
Display.....	4
Rear Panel.....	5
<b>Step 1: Connections.....</b>	<b>6</b>
1 Connecting speakers.....	6
• Speaker layout .....	6
• Height speaker types .....	7
• Instructions on how to connect speakers.....	8
2 Connecting the TV and players .....	9
• HDMI cable connection .....	9
• Connecting Components without HDMI .....	10
3 Other connections .....	11
<b>Step 2: Initial Setup .....</b>	<b>12</b>
1 AccuEQ Room Calibration .....	12
2 Source Connection.....	13
3 Remote Mode Setup .....	14
4 Network Connection.....	14
<b>Step 3: Playing Back .....</b>	<b>16</b>
1 Basic operations.....	16
• Remote controller parts name.....	16
2 Network Functions.....	17
3 AirPlay® .....	17
4 BLUETOOTH® function .....	18
5 AM/FM Radio .....	18
6 Multi-zone.....	19
• Making Multi-zone Connection.....	19
• Performing Multi-zone Playback .....	20
7 Quick Setup menu.....	21
8 Other useful functions .....	22
Troubleshooting.....	23
Specifications .....	24
Table of display resolutions .....	25
Resolutions supported by HDMI.....	25
Supplied Accessories .....	Back cover

## Advanced Manual (on the web)

Advanced Manual is always updated with the latest information and its user friendly interface, which does not matter whether you access from PC or Smartphone, helps you to understand more deeply about the AV Receiver. Advanced Manual is consisted of the following chapters.

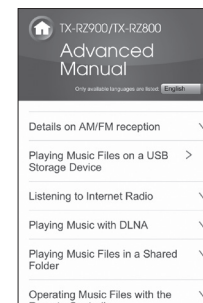

- Details on AM/FM reception
- Playing Music Files on a USB Storage Device
- Listening to Internet Radio
- Playing Music with DLNA
- Playing Music Files in a Shared Folder
- Operating Music Files with the Remote Controller
- Using the Listening Modes
- Advanced Settings (Setup Menu)
- Operating Other Components with the Remote Controller
- Advanced Connection
- Connecting and Operating Onkyo RI Components
- Control Function between the Unit and External Component
- Firmware Update
- Troubleshooting
- Reference Information



Advanced Manual found here  
<http://www.onkyo.com/manual/txrz900800/adv/en.html>

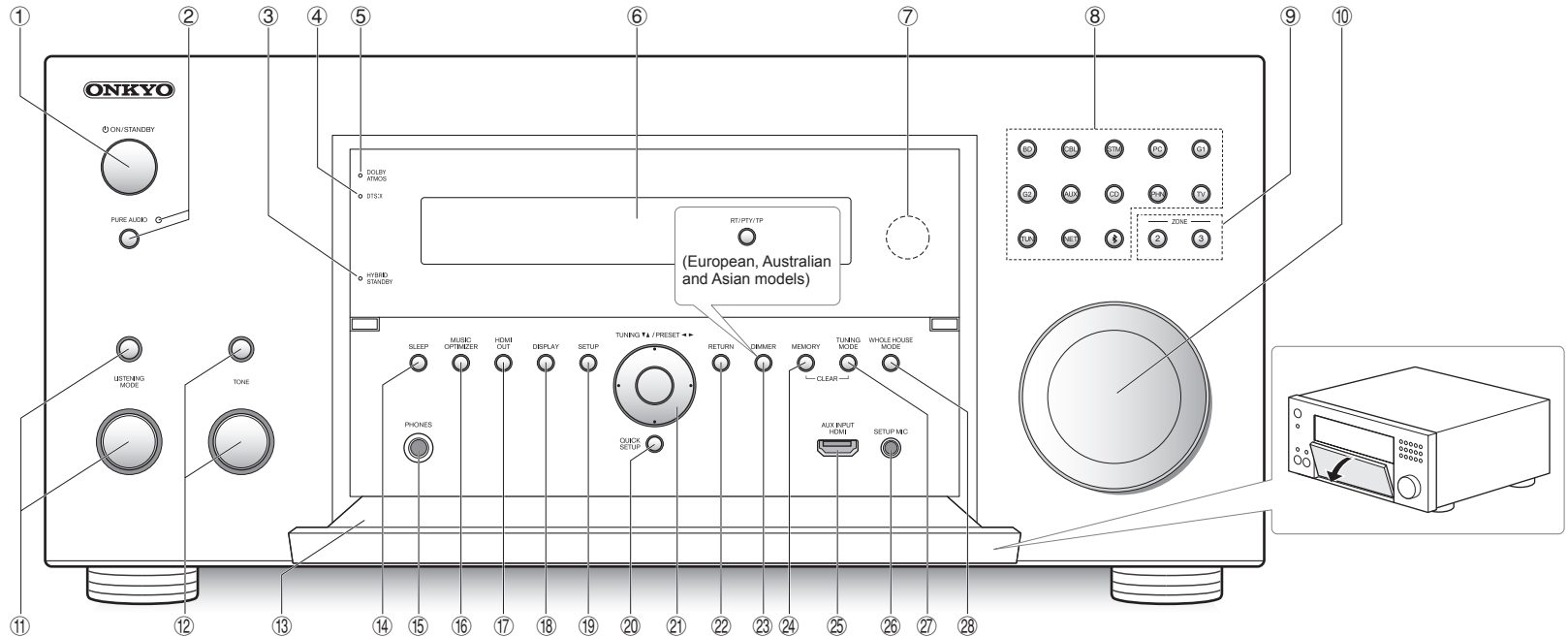

## Front Panel

- ① **ON/STANDBY button:** Turns the unit on or into standby mode.
- ② **PURE AUDIO button and indicator:** The display and analog video circuits are turned off to switch the unit to PURE AUDIO mode and provide purer sound.
- ③ **HYBRID STANDBY indicator:** Lights if the unit enters standby mode when the HDMI Standby Through, USB Power Out at Standby, Network Standby or BLUETOOTH Wakeup function is enabled.
- ④ **DTS:X indicator:** Lights when playing DTS:X.
- ⑤ **DOLBY ATMOS indicator:** Lights when playing Dolby Atmos.
- ⑥ **Display**
- ⑦ **Remote control sensor:** Receives signals from the remote controller.
- ⑧ **Input selector buttons:** Switches the input to be played. Each button is assigned to the following jacks.
- | Button | Jack     | Button | Jack   |
|--------|----------|--------|--------|
| BD     | BD/DVD   | G2     | GAME 2 |
| CBL    | CBL/SAT  | AUX    | AUX    |
| STM    | STRM BOX | CD     | CD     |
| PC     | PC       | PHN    | PHONO  |
| G1     | GAME 1   | TV     | TV     |
- Use the TUN button for AM/FM radio, the NET button for network features such as Internet radio and USB playback, and the  $\mathbb{X}$  button for BLUETOOTH features.
  - The assigned jacks can be changed. For how to make settings, see "1. Input/Output Assign" in "Advanced Settings (Setup Menu)" in the Advanced Manual.
- ⑨ **ZONE2/3 button:** Controls the multi-zone function.
- ⑩ **MASTER VOLUME:** Allows you to adjust the volume.
- ⑪ **LISTENING MODE button/dial:** Allows you to select the listening mode. Press the button repeatedly to select a category from "MOVIE/TV", "MUSIC", "GAME", then turn the dial to change the mode.
- ⑫ **TONE button/dial:** Adjusts the high tone and low tone. Press the button repeatedly to select the item to adjust from "Bass", "Treble" and "Phase Matching Bass", and turn the dial to adjust.
- ⑬ **Front flap**
- ⑭ **SLEEP button:** Allows you to specify a time period after which the unit enters standby automatically.
- ⑮ **PHONES jack:** Stereo headphones with a standard plug are connected.

- ⑮ **MUSIC OPTIMIZER button:** Turns on/off the MUSIC OPTIMIZER function that improves the quality of the compressed audio.
- ⑯ **HDMI OUT button:** Allows you to select the HDMI jack to output video signals.
- ⑰ **DISPLAY button:** Switches the information on the display.
- ⑱ **SETUP button:** Used when making settings.
- ⑲ **QUICK SETUP button:** Displays the Quick Setup menu that allows you to quickly access the frequently used setting items including sound quality adjustment.
- ⑳ **Cursor buttons, TUNING▼▲ button, PRESET◀▶ button and ENTER button:** Moves the cursor and confirms the selection. When listening to AM/FM broadcasting, tune in to the station with TUNING▼▲ or select the registered station with PRESET◀▶.
- ㉑ **RETURN button:** Returns the display to the previous state.
- ㉒ **DIMMER button (North American models):** Switches the brightness of the display.  
**RT/PTY/TP button (European, Australian and Asian models):** Can be used when receiving the station transmitting text information.
- ㉓ **MEMORY button:** Registers a radio station.
- ㉔ **AUX INPUT HDMI jack:** A HD camera or such other device is connected.
- ㉕ **SETUP MIC jack:** The supplied speaker setup microphone is connected.
- ㉖ **TUNING MODE button:** Switches the tuning mode.
- ㉗ **WHOLE HOUSE MODE button:** Enables the WHOLE HOUSE MODE function to play the same source in all the multi-zone connected rooms.

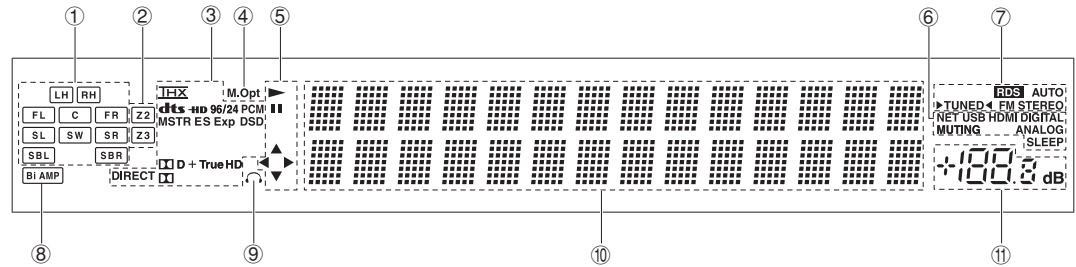

## Display

- ① **Speaker/Channel display:** Displays the output channel that corresponds to the selected listening mode.
- ② **Z2/ Z3:** Lights when the output to Zone 2/ Zone 3 is set to on.
- ③ **Lights according to the type of input digital audio signals and the listening mode.**
- ④ **Stays lit when Music Optimizer is enabled.**
- ⑤ **Lights when playing NET or USB.**
- ⑥ **"NET":** Lights when "NET" input is selected and the unit is connected to the network. It will flash if the connection is not correct.  
**"USB":** Lights when input is "NET" and USB is connected and selected. It will flash if the connection is not correct.  
**"HDMI":** Lights when HDMI signals are input and the HDMI input is selected.  
**"DIGITAL":** Lights when digital signals are input and the digital input is selected.  
**"MUTING":** Flashes when muting is on.  
**"ANALOG":** Lights when analog signals are input and the analog input is selected or when HDMI and digital signal inputs are not assigned.  
**"SLEEP":** Lights when the sleep timer is set.
- ⑦ **Lights in the following conditions.**  
**"RDS" (European, Australian and Asian models):** Receiving RDS broadcasting.  
**"AUTO":** Tuning mode is auto.  
**"▶TUNED◀":** Receiving AM/FM radio. ▶◀ flashes while tuning is automatically performed.  
**"FM STEREO":** Receiving FM stereo.
- ⑧ **"Bi AMP":** Using bi-amp.
- ⑨ **Stays lit when headphones are connected.**
- ⑩ **Displays various information of the input signals.**  
Pressing DISPLAY displays the type of input digital signals and the listening mode.
- ⑪ **Shows the volume level.**

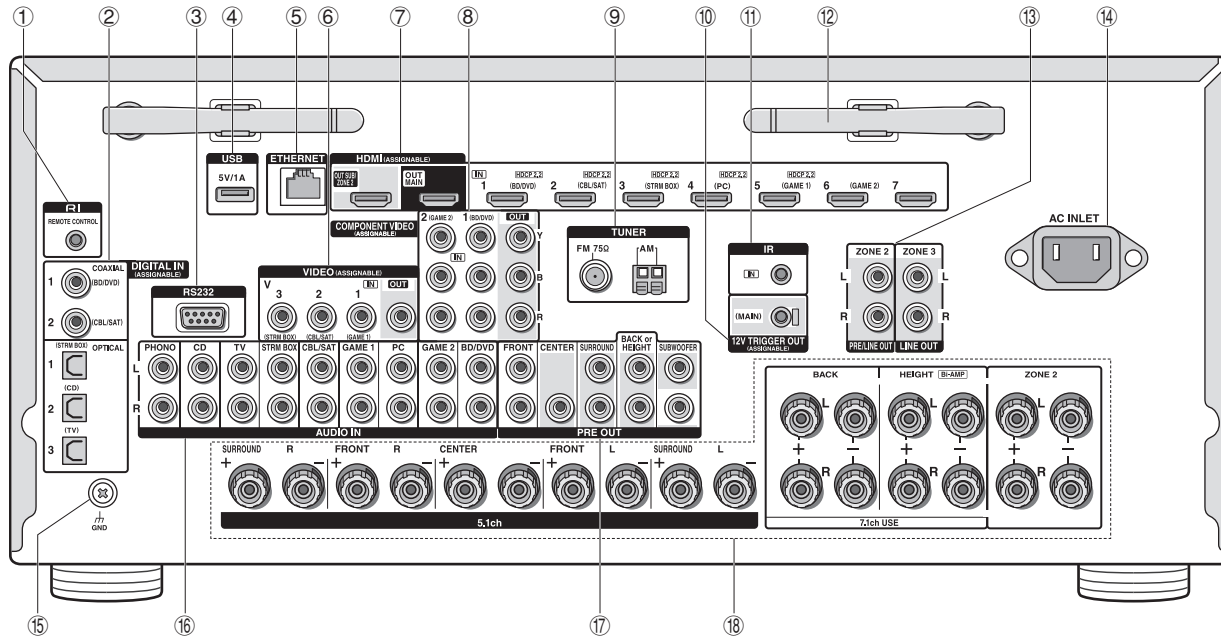

## Rear Panel

- ① **RI REMOTE CONTROL jack:** An Onkyo product with RI jack can be connected and synchronized with this unit.
- ② **DIGITAL IN COAXIAL/OPTICAL jacks:** Digital audio signals are input.
- ③ **RS232 port:** Connected to the home control system. (\*)
- ④ **USB port:** A USB storage device is connected so that music files stored in it can be played. Connect a USB device with a USB cable to supply it with power.
- ⑤ **ETHERNET port:** Used for LAN connection
- ⑥ **VIDEO IN/OUT jacks:** Composite video input/output jacks.
- ⑦ **HDMI IN/OUT jacks:** Digital video signals and audio signals are transmitted between the unit and the connected devices.
- ⑧ **COMPONENT VIDEO IN/OUT jacks:** Component video input/output jacks.

- ⑨ **TUNER AM/FM(75Ω) terminal:** The supplied antennas are connected.
- ⑩ **12V TRIGGER OUT MAIN jack:** Allows you to connect a device with 12V trigger input jack to enable link operation between the device and the unit. (\*)
- ⑪ **IR IN jack:** Connected to the multiroom remote control kit. (\*)
- ⑫ **Wireless antenna:** Used for Wi-Fi connection or when using a BLUETOOTH enabled device. Adjust their angles according to the connection status.

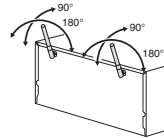

- ⑬ **PRE/LINE OUT ZONE 2 jack, LINE OUT ZONE 3 jack:** Audio output jack connected to the power amplifier and pre-main amplifier for multi-zone playback in a separate room.
- ⑭ **AC INLET:** The supplied power cord is connected.
- ⑮ **GND terminal:** The ground wire of the turntable is connected.
- ⑯ **AUDIO IN jacks:** Analog audio signals are input.
- ⑰ **PRE OUT jacks:** A power amplifier or subwoofer with built-in amplifier is connected.
- ⑱ **Speaker terminals:** Speakers are connected. To use the Multi-zone function, connect the speakers in the separate room to the ZONE2 speaker terminals.

\* Special devices or cable connections are necessary to use the ③, ⑩ and ⑪ functions. Contact the specialized stores for more information.

# Step 1: Connections

## 1 Connecting speakers

### Speaker layout

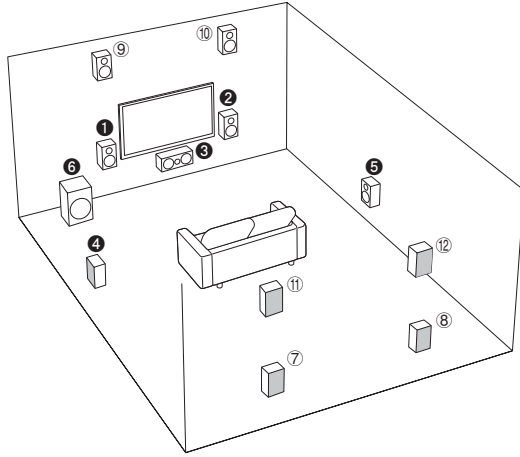

**Important:** The power cord must be connected only after all other connections are completed.

- ① ② Front speakers
- ③ Center speaker
- ④ ⑤ Surround speakers
- ⑥ Subwoofer
- ⑦ ⑧ Back speakers
- ⑨ ⑩ Height speakers (Front High)
- ⑪ ⑫ Height speakers (Rear High)

• 5.1 ch: ①②③④⑤⑥

• 7.1 ch: ①②③④⑤⑥+⑦⑧, or

①②③④⑤⑥+⑨⑩, or

①②③④⑤⑥+⑪⑫

- To enjoy the Dolby Atmos listening mode, height speakers or back speakers need to be installed. There are a variety of height speakers apart from this type. See the next section "Height speaker types" for details.

### Characteristics of speaker types

①② output front stereo sound and ③ outputs center sound such as dialogs and vocals. ④⑤ create back sound field. ⑥ reproduces bass sounds and creates rich sound field.

Connecting ⑦⑧, ⑨⑩, or ⑪⑫ speakers enables playback in 7.1 ch configuration.

⑦⑧ (back) speakers improve sense of envelopment created by back sound field as well as seamlessness of back sounds, providing more natural sound experiences in the sound field. ⑨⑩ and ⑪⑫ (height) speakers produce surround effects on a height plane. Note that this unit can perform optimal sound field processing for the type of height speakers actually installed and registered in Initial Setup.

You can connect both back speakers and height speakers at the same time, but you can only output audio from one of these at a time. When connected at the same time, you can switch speakers to prioritize in the Quick Setup menu that appears when you press the Q button on the remote controller (Speaker Layout function). For details, see "7 Quick Setup menu" of "Step 3: Playing Back".

- The speaker setting is 7.1 channels at the time of purchase. You can change it manually or by using automatic speaker setting.
- To use the multi-zone function, see "6 Multi-zone" in "Step 3: Playing Back".

**Important:** Connect speakers with 4  $\Omega$  to 16  $\Omega$  impedance. You have to change the setting if any of the speakers have 4  $\Omega$  or more to less than 6  $\Omega$  impedance. Using a speaker with less impedance than the setting may result in failure. You can set up by viewing the guidance displayed on the TV screen. Select the item with the cursor buttons of the remote controller and press ENTER to confirm your selection. To return to the previous screen, press RETURN. Press RCV and then SETUP on the remote controller. Select "2. Speaker" - "Configuration" - "Speaker Impedance" - "Configuration" - "Speaker Impedance" and change the default value from "6ohms" to "4ohms".

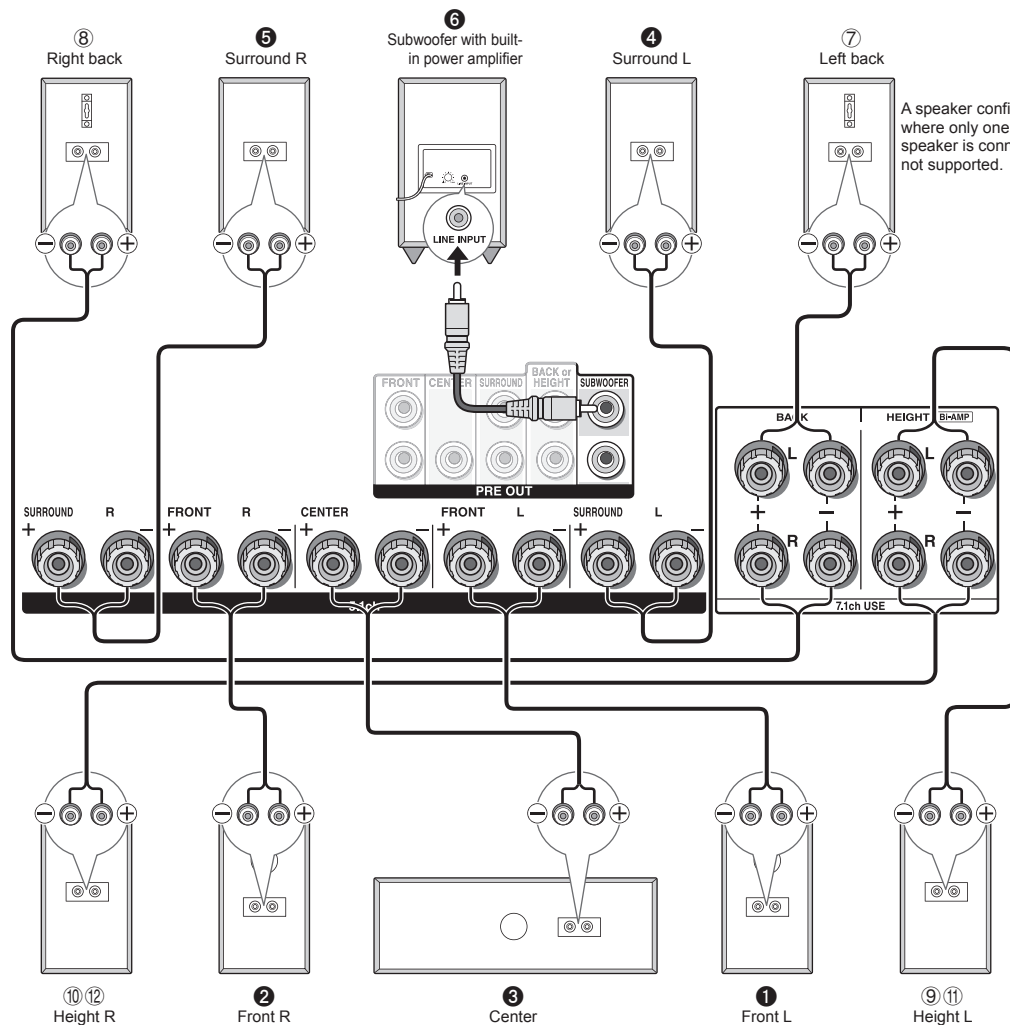

A speaker configuration where only one back speaker is connected is not supported.

### Height speaker types

#### Installing speakers in ceiling

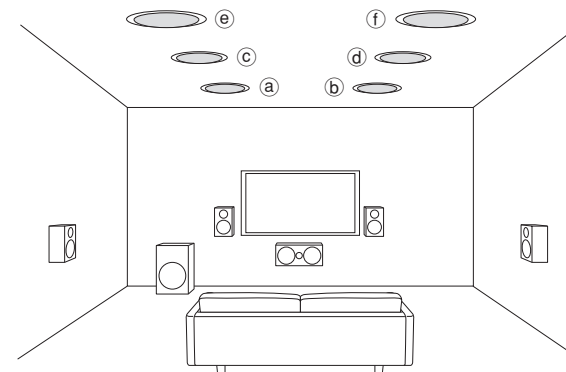

- Ⓐ Ⓑ Top front
- ⓒ ⓓ Top middle
- ⓔ ⓕ Top Rear

Ceiling speakers, etc. are used for maximizing effects in Dolby Atmos or Dolby Surround listening mode. Install Top Front speakers so that they are positioned at a point between directly above the listening position and directly above the front speakers. Install Top Middle speakers so they are directly above the listening position. Install Top Rear speakers so they are positioned at a point between directly above the listening position and directly above the back speakers. You can select ⒶⒷ, ⓒⓓ, or ⓔⓕ on this unit. For connection with the unit, use the HEIGHT speaker terminals.

- Dolby Laboratories recommends placing the speakers as described in "Installing speakers in ceiling" to obtain the best Dolby Atmos effect.

Make correct connection between the unit's jacks and speaker's jacks (+ to + and - to -).



### Using Dolby Enabled Speakers

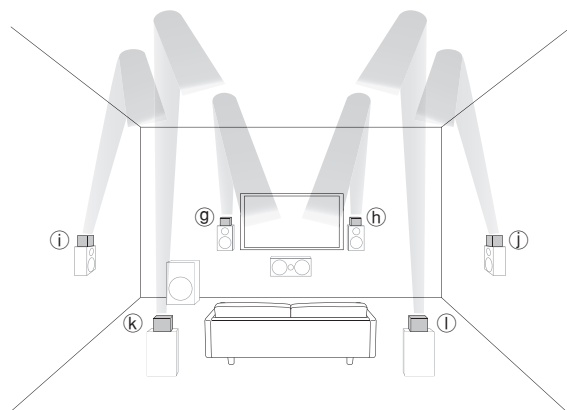

- g h Dolby Enabled Speaker (Front)
- i j Dolby Enabled Speaker (Surround)
- k l Dolby Enabled Speaker (Back)

A Dolby Enabled Speaker is specially designed to be used as a Height speaker. There are two types of Dolby Enabled Speakers; types placed on top of other speakers such as front speakers and surround speakers (\*), and types that are integrated with the normal speakers. Dolby Enabled Speakers placed with their diaphragms facing toward the ceiling create higher effect in the Dolby Atmos and Dolby Surround listening modes by providing sounds echoing off the ceiling. You can select g h, i j, or k l on this unit. For connection with the unit, use the HEIGHT speaker terminals.

\* You can put k l on top of back speakers, but even if you connect both back speakers and k l speakers at the same time, you can only output audio from one of these at a time.

When playing Dolby Atmos, the speakers required depend on how you have setup your back speakers or height speakers. The following shows speaker combinations.

Connection pattern	Back or Height	Front		
		Center	Surround	
1	Back	⊗	○	⊗
2	Front High	⊗	○	○
3	Rear High	⊗	○	○
4	Top Front	⊗	○	○
5	Top Middle	⊗	○	○
6	Top Rear	⊗	○	○
7	Dolby Enabled Speaker (Front)	⊗	○	○
8	Dolby Enabled Speaker (Surround)	⊗	○	⊗
9	Dolby Enabled Speaker (Back)	⊗	○	⊗

⊗Required ○Optional \*Connection of a subwoofer is optional.

### Instructions on how to connect speakers

Cut and remove the plastic coating from the end of the speaker cable, twist the core and connect it to the terminal. Make correct connection between the unit's jacks and speaker's jacks (+ to + and - to -) for each channel. If connection is wrong, a bass sound may become poor due to reverse phase. Up to two subwoofers with built-in power amplifier can be connected to the SUBWOOFER jacks. Set the cut-off filter selection switch of the subwoofer to DIRECT. If the subwoofer does not have a cut-off filter selection switch but has a cut-off frequency adjusting dial, turn it to the maximum frequency. If your subwoofer does not have built-in power amplifier, you can connect a power amplifier between the unit and the subwoofer.

- Short-circuiting the + cable and - cable or contacting the cable core to the rear panel of the unit may cause failure. Also do not connect two or more cables to one speaker terminal or one speaker to several terminals.

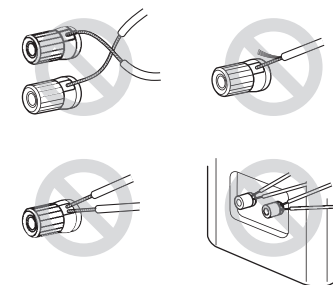

**When using commercially available banana plugs:** tighten the speaker terminals to the end and then insert the banana plugs. Do not insert the core of speaker cable directly into the hole for banana plug of speaker terminal. (North American model)

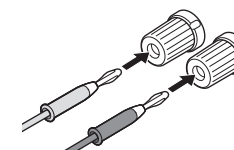



## 2 Connecting the TV and players

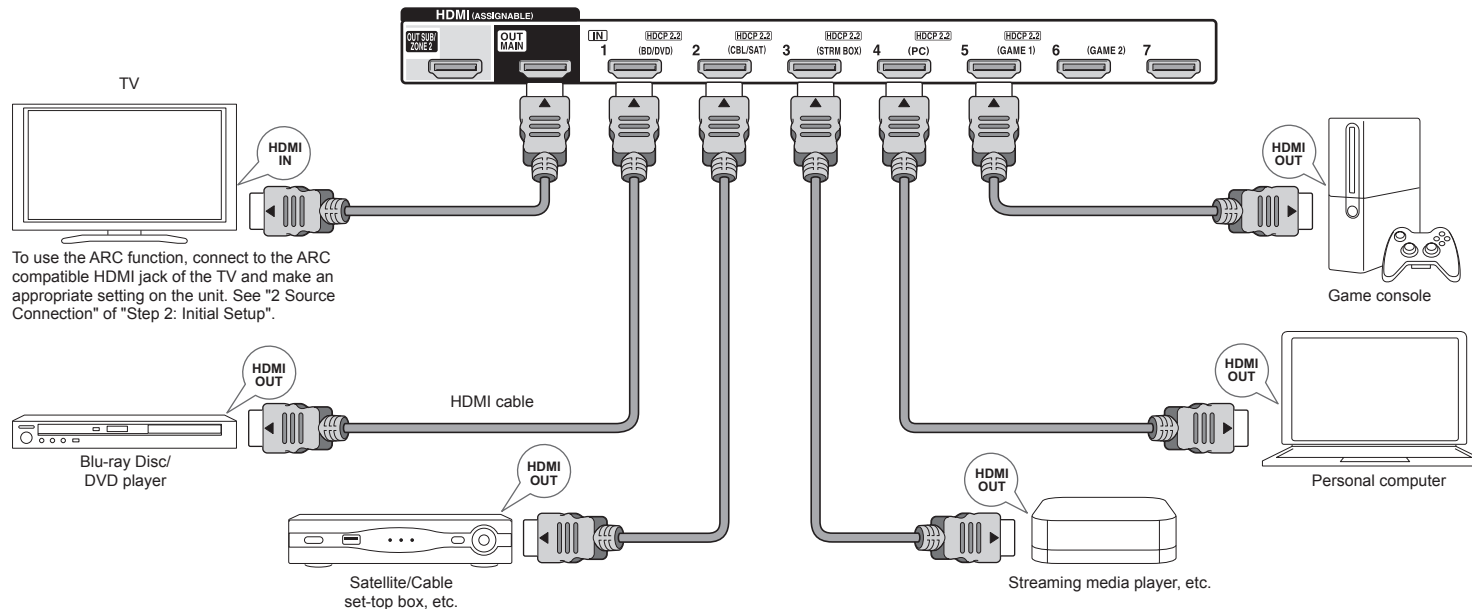

### HDMI cable connection

Refer to the above figure and connect the player to the HDMI jack on the back of this unit. For example, connect a Blu-ray Disc Player to the HDMI IN1 (BD/DVD) jack. To play the player, press the INPUT SELECTOR button on the remote controller with the same name as the jack to which you connected the player so that the input on the unit is selected.

To connect the TV and the unit, connect the HDMI OUT MAIN jack of the unit and the HDMI IN jack of the TV using an HDMI cable. With this connection, it becomes possible to display the setting screen of the unit on the TV or transmit video/audio signals from the player to the TV. If your TV supports ARC (Audio Return Channel), it is possible to play the TV sound with the AV receiver's

speakers with this connection only. If your TV does not support ARC, you need, in addition to the HDMI OUT MAIN jack connection, a digital optical cable connection between the digital audio out optical jack of the TV and the DIGITAL IN OPTICAL jack of the unit or an analog audio cable connection between the audio output jack of the TV and the AUDIO IN TV jack of the unit.

### ● Audio connection with a TV not supporting ARC

\* Select an appropriate connection for your TV.

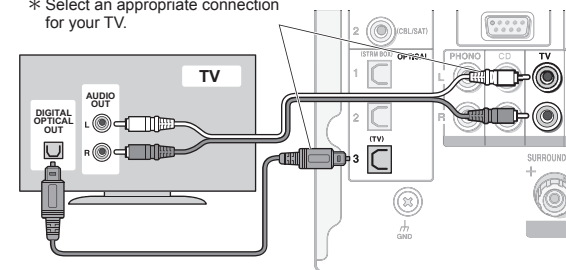

The unit supports the HDMI Standby Through function that allows transmission from players to the TV even if the unit is in standby. You have to modify the settings to enable the input selection link with CEC (Consumer Electronics

Control) compliant device, connection with ARC compatible TV, and HDMI Standby Through function. See "2 Source Connection" of "Step 2: Initial Setup".

- Another TV can be connected to the HDMI OUT SUB jack. In this case, press the HDMI OUT button on the main unit several times to display "SUB" or "MAIN+SUB" and select the output method. You have to modify the settings to enable the CEC functions, such as ARC, for the TV connected to the HDMI OUT SUB jack. Set "Step 3: Playing Back" - "7 Quick Setup menu" - "Control TV" to "SUB".
- To enjoy HDCP2.2 protected video, connect the player to one of the HDMI IN1 to IN5 jacks and connect the HDMI output jack on this unit and to a HDCP2.2 compatible HDMI input jack on the TV. You will be unable to view images protected by HDCP2.2 if your TV does not have a HDCP2.2 compatible input jack.
- To play 4K or 1080p video, use a high speed HDMI cable or high speed HDMI with Ethernet cable.

## Connecting Components without HDMI

If your AV component does not have HDMI jack, use an available jack of your component for cable connection with this unit.

- \* It is possible to change assignment of the input jacks and input selector buttons. For how to make settings, see "1. Input/Output Assign" in "Advanced Settings (Setup Menu)" in the Advanced Manual.

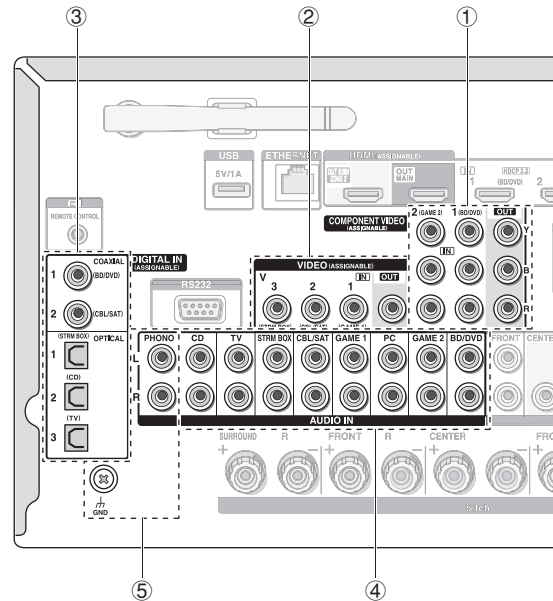

### Video signal connection

The unit has a video upconversion function. For details, see the next section.

- ① A TV with component video input jacks or a player with component video output jacks can be connected.
  - \* Only images input through the COMPONENT VIDEO IN jacks can be output through the COMPONENT VIDEO OUT jacks.

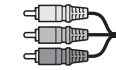

Component video cable

- \* Its transmitted video has higher quality than that of composite video cable.

- ② A TV with composite video input jacks or a player with composite video output jacks can be connected.
  - \* Only images input through the VIDEO IN jack (composite) can be output through the VIDEO OUT jack.



Composite video cable

### Audio signal connection

- ③ A player with a digital audio out jack can be connected.
  - \* The DIGITAL IN OPTICAL jack of the unit has a cover. Push in the cable against the cover as it is turned inside.
- ④ A player with analog audio out jacks can be connected. When using jacks ① and ② for video input, connect to the audio input jacks corresponding to the jacks connected at ① and ②. (For example, when video input connection is to the ① BD/DVD jack, the audio input connection should also be to the ④ BD/DVD jacks.)



Digital optical cable (OPTICAL)

- \* The DIGITAL IN OPTICAL jack of the unit has a cover. Push in the cable against the cover as it is turned inside.



Digital coaxial cable (COAXIAL)

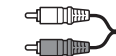

Analog audio (RCA) cable

- ⑤ Connect a turntable that uses an MM type cartridge and does not have a built-in audio equalizer. If the connected turntable has a built-in audio equalizer, connect it to the ④ analog audio input jack.
  - \* If it uses an MC type cartridge, install an audio equalizer compatible with MC type cartridge between the unit and the turntable by connecting it to the ④ analog audio input jack. For details, refer to the turntable's instruction manual.
  - \* If the turntable has a ground wire, connect it to the GND terminal of this unit. If connecting the ground wire increases noise, disconnect it.

### Video upconversion function

Video signals input to the VIDEO IN jack or the COMPONENT VIDEO IN jacks will be upconverted to HDMI signals and then output from the HDMI output jack.

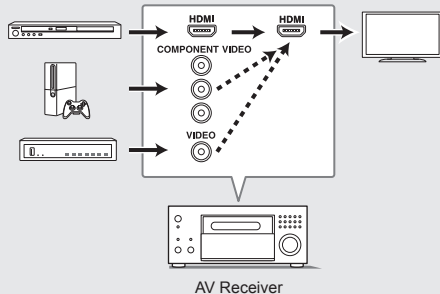

- \* When you upconvert video signals input to the COMPONENT VIDEO IN jacks and output them from the HDMI OUT jack, set the output resolution of the player to 480i or 576i. If the input has 480p/576p or higher resolution, a message prompting you to change the resolution setting will appear. If your player does not support 480i or 576i output, use the VIDEO IN jack.
- \* If multiple video signal inputs are put into one input system, HDMI signal output is prioritized.

## 3 Other connections

### AM/FM antenna connections

Connect the antennas to listen to AM/FM broadcast. When listening to the broadcast for the first time, adjust the antenna position and orientation to get the best reception.

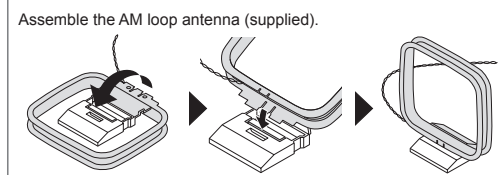
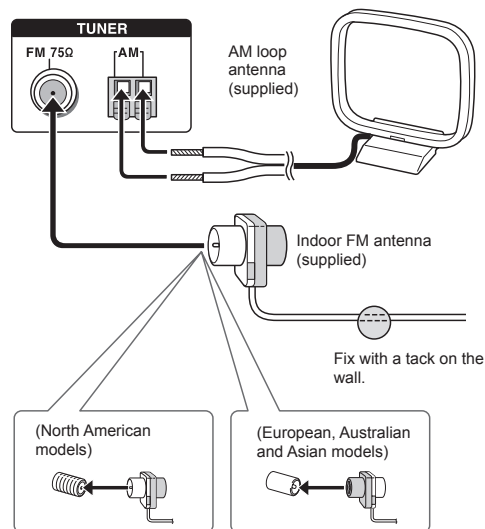

### Network connection

You can enjoy Internet radio, DLNA, and AirPlay by connecting the unit to LAN. The unit can be connected to the router with an Ethernet cable or to the wireless LAN router with Wi-Fi connection. In case of wired connection, connect the LAN cable to the ETHERNET port. See "4 Network Connection" of "Step 2: Initial Setup" for Wi-Fi settings.

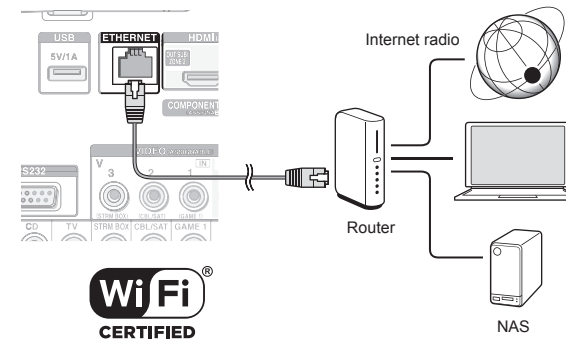

### Headphones connection

Connect stereo headphones with a standard plug (1/4 inch or  $\phi$  6.3 mm) to the PHONES jack on the front panel. Sound from the speakers will be off while you are using the headphones.

- If you selected any other listening mode than Pure Audio, Stereo, Mono and Direct, connecting headphones will switch the listening mode to Stereo.

### Power cord

This model includes a removable power cord. Connect the power cord to AC INLET of the unit and then connect to the outlet. Always disconnect the outlet side first when disconnecting the power cord. When the unit is turned on, a large instantaneous current may flow affecting functionality of the computer and other devices, so it is recommended to use a separate outlet.

# Step 2: Initial Setup

"Initial Setup" automatically starts on the television when you first turn the unit on.



Settings proceed in the following order:

## 1 AccuEQ Room Calibration

- Automatic calibration for optimum speaker settings

## 2 Source Connection

- Checking that each input source is connected correctly
- HDMI link function settings

## 3 Remote Mode Setup

- Settings required to operate other AV Components with the Remote Controller

## 4 Network Connection

- Checking network connections
- Wi-Fi settings

\* **Firmware update notification:** If the unit is connected via LAN and there is firmware update available, the "Firmware Update Available" message will appear. To execute updating, select "Update Now" with the cursor buttons of the remote controller and press ENTER.

When "Completed!" appears, press  $\odot$ ON/STANDBY on the main unit to turn the unit into standby mode. Then updating will be completed. (The unit automatically turns itself into standby mode after about 3 minutes even if you don't press  $\odot$ ON/STANDBY, and updating will be complete.)

## Before Start

Setup is performed as a series of responses to questions asked by the unit. Select the item with the cursors of the remote controller and press ENTER to confirm your selection. To return to the previous screen, press RETURN.

- Switch the input on the TV to that assigned to the unit.

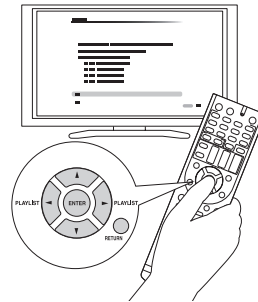

Select the language first. Next, a summary of the initial settings is displayed. Select "Yes" in this screen and press ENTER on the remote controller.

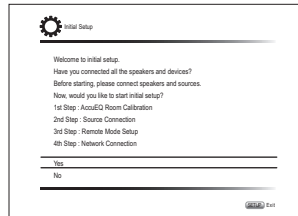

**Re-doing initial setup:** If you terminate the procedure on the way or change the setting made in the initial setup and want to call up the setup wizard again, press RCV and then SETUP on the remote controller, select "8. Miscellaneous" - "Initial Setup", and press ENTER.

## 1 AccuEQ Room Calibration

The test tone coming from each speaker will be measured to enable setting of the number of speakers, volume level, each speaker's optimum crossover frequencies, and distance from the primary listening position, and also enable correction of distortion caused by the room acoustic environment.

- You cannot return to the previous screen during speaker setup, even if you press RETURN.

### 1. Place the speaker setup microphone.

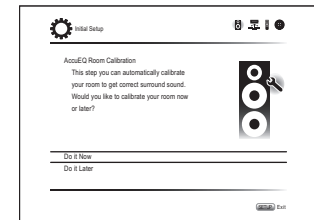

When the above screen is displayed, before starting the procedure, place the supplied speaker setup microphone at the measurement position ★ by referring to the following figure.

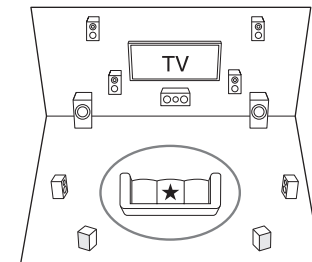

○ : Listening area      ★ : Measurement position with microphone

## 2 Source Connection

You can check the connections for each of the inputs and configure the HDMI link function.

1. When the Source Connection start screen is displayed, select "Yes, Continue" with the cursors and press ENTER.

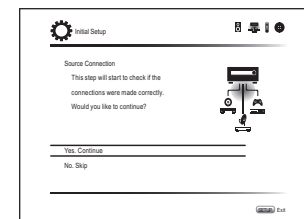

2. Select the desired input to check the connection and press ENTER.

Start playback of the selected device. If connection is correct, video/audio of the input source selected on the unit will be played.

3. After checking the connection, select "Yes" with the cursors and press ENTER.

- If you select "No" and press ENTER, the error cause will be displayed. Follow the guidance to remove the error cause and check the connection again.

4. Select "Yes" with the cursors and press ENTER on the remote controller to check the connection of other inputs or select "No, Done Checking" and press ENTER to skip.

If you select "Yes", you will return to the screen of step 2.

If you select "No, Done Checking", you will proceed to step 5.

5. Settings for the CEC link function.

To enable the HDMI link function with CEC compatible equipment, select "Yes", then select "Yes" again in the next screen.

- \* Correct measurement will not be possible if the microphone is held by hand. Measurement is not possible if headphones are being used.
- \* The subwoofer sound may not be detected since it is extremely low frequencies. Set the subwoofer volume to around the half of its maximum volume.
- \* Measurement may be interrupted if there is ambient noise or radio frequency interference. If this occurs, close the window and turn off the home appliance and fluorescent light.

2. After placing the microphone at the measurement position, select "Do it Now" with the cursors and press ENTER.
3. When "Please plug microphone that came in a box with AV receiver" is displayed, connect the microphone to the SETUP MIC jack of the unit.

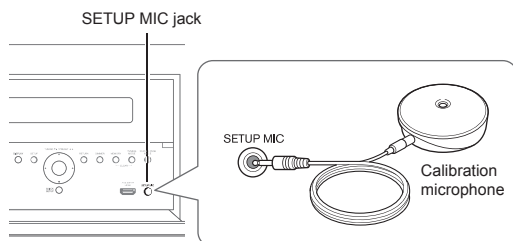

4. Set the speakers you have connected and the type of Height Speakers.

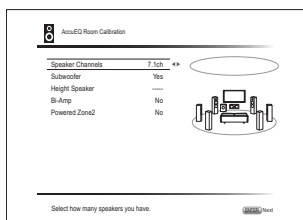

When the screen above is displayed, set the items with the cursors on the remote controller. The image on the screen changes as you choose the number of channels in "Speaker Channels", so refer to it when performing the settings. After completing all the settings, press ENTER on the remote controller.

After this, follow the guidance displayed on the TV screen.

- When the cursor is on an item, the content of the item will be shown in the lower part of the screen.

5. The test tones sound from the connected speakers and automatic speaker setting starts.

Measurement will be made three or more times for each speaker. It takes several minutes to be completed. Keep the room as quiet as possible during measurement. If any of the speakers do not produce the test tone, check for disconnection.

- During measurement, each speaker outputs the test tones at a high volume. Be careful of sound leak that may disturb your neighbors, or be careful not to frighten young children.

6. When the measurement is completed, the measurement result is displayed.

Press ◀/▶ on the remote controller to check the settings. Press ENTER with "Save" selected. To have the settings reflected for all the speakers, select "On (All Channels)" in the next screen and press ENTER on the remote controller.

- Select "On (Except Front Left / Right)" to disable just the front speakers.
- If there is an error message, follow the on-screen instruction to remove the error cause. If the subwoofer was not detected, turn the volume of the subwoofer up to maximum and then select "Retry".

### About THX playback

THX recommends setting the speakers manually if you use THX-certified speakers or playing back with THX listening modes.

- THX recommends setting the crossover frequency to "80Hz(THX)" manually.
- Due to the electrical complexities and the interaction with the room, you may notice irregular results when setting the level or distance of each speaker. If this happens, THX recommends setting the speakers and the subwoofer manually.

7. When "Please unplug setup microphone." is displayed, disconnect the microphone.

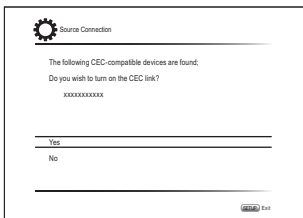

If you select "Yes", the connection with ARC compatible TV and HDMI Standby Through function will be set to "On" and enabled.

### 3 Remote Mode Setup



You can enable operation of the other components using the remote controller of the unit. When the Remote Mode Setup start screen is displayed, select "Yes, Continue" with the cursors and press ENTER on the remote controller. Follow the guidance to select the desired REMOTE MODE button and in the keyboard screen, enter the first three characters of the brand name of the device you are going to program and search for the remote control code. The guidance will also explain how to set the remote controller.

## 4 Network Connection

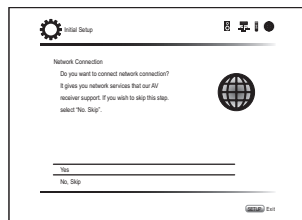

You can check the network connection and make the Wi-Fi setting. When the Network Connection start screen is displayed, select "Yes" with the cursors and press ENTER on the remote controller. If you select "Wired" in the next screen, you can view the LAN cable connection status. To make the Wi-Fi setting, select "Wireless", press ENTER on the remote controller and follow the sections below.

#### Make the following preparations.

Wi-Fi connection requires an access point such as wireless LAN router (\*). Write down the SSID and password (key) of the access point if they are shown in the label of the main body. If the access point has an automatic setting button (may be called differently according to the manufacturer), you can set up without inputting the password.

For how to use the automatic setting button of the access point, refer to its instruction manual.

\* The unit supports Wi-Fi connection with 2.4 GHz access point.

#### 1. Select the method of Wi-Fi connection with the cursors and press ENTER.

**Scan Networks:** Search for an access point such as a wireless LAN router from this unit.

**Use iOS Device (iOS7 or later):** If you are using an iOS device, you can connect easily with Wi-Fi just by sharing the iOS device's Wi-Fi settings with this unit.

#### ■ If you selected "Scan Networks"

#### 2. Select the SSID of the access point to be connected with the cursor buttons and press ENTER.

When the SSID of the access point appears on the TV screen, select the desired access point.

- If you changed the initial setting of the access point to skip password entry, step 3 is unnecessary.
- If you changed the initial setting of the access point to hide the SSID, see "When the access point is not displayed".

#### 3. Select and set the authentication method.

The "Enter Password" screen may be displayed automatically if the wireless LAN router does not have an automatic setting button.

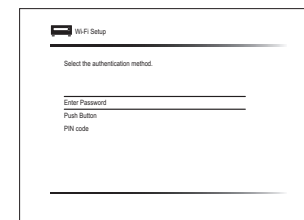

When this screen is displayed, select and set one of the three authentication methods: "Enter Password", "Push Button" and "PIN code". See below for details of and how to set each method.

**Enter Password:** Enter the password of the access point to establish connection.

- ① Select "Enter Password" with the cursor buttons and press ENTER.
- ② Enter the password (\*) on the keyboard screen, select "OK" with the cursor buttons and press ENTER.

\* Select "A/a" and press ENTER to toggle between upper and lower case. Select "←" or "→" and press ENTER to move the cursor to the selected direction. Select  $\langle \boxtimes \rangle$  and press ENTER to delete the character at the left of the cursor position. To select whether to mask the password with "\*" or display it in plain text, press D on the remote control. Press +10 on the remote controller to switch between upper and lower case. Press CLR to delete all the input characters.

- ③ If the security method of the access point to be connected is WEP, select "Default Key ID", and press ENTER.

**Push Button:** Use the automatic setting button of the access point to establish connection.

- ① Select "Push Button" with the cursor buttons and press ENTER.
- ② Hold down the automatic setting button of the access point for the necessary seconds, select "OK" with the cursor buttons and press ENTER.

**PIN code:** Select this method when the automatic setting button of the access point is beyond the reach. Select "PIN code" with the cursor buttons and press ENTER to display the 8-digit PIN code. Register the displayed PIN code to the access point, select "OK" with the cursor buttons and press ENTER. For how to register the PIN code to the access point, refer to its instruction manual.

#### 4. Select "Yes, Start to Check" in the network connection confirmation screen.

##### When the access point is not displayed

Select "Other..." with the ► cursor on the remote controller and press ENTER to display the keyboard screen. Input the SSID and password. Make the following settings according to the router setting.

##### ■ WPA/WPA2 method

Select "WPA" or "WPA2" in "Security Method", and press ENTER.

##### ■ WEP method

Select "WEP" in "Security Method" and select "Default Key ID", and press ENTER.

- If encryption setting has not been made on the wireless LAN router, select "None" in "Security Method", and press ENTER.

#### ■ When "Use iOS Device (iOS7 or later) is selected

2. On the iOS device, go to "Settings"->"Wi-Fi" and turn on the setting, then select this unit in "SETUP NEW AIRPLAY SPEAKER".

3. Tap "Next".

4. Select "Yes, Start to Check" in the network connection confirmation screen.

#### \* Privacy policy

A confirmation screen asking you to agree to the privacy policy is displayed during network setting. Select "Yes" and press ENTER to indicate agreement.

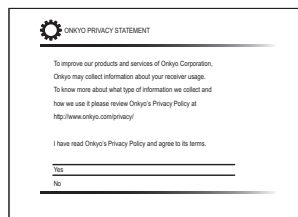

#### ■ If connection is successful

"Successfully Connected" is displayed on the screen.

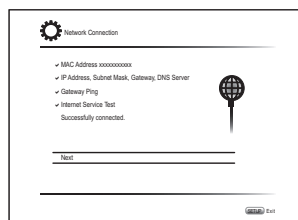

If this is not displayed, try doing the setting again. If "Push Button" connection with the wireless LAN router does not work, try "Enter Password".

#### ■ Terminating initial setup

After finishing the initial setup, keep "Finished" selected and press ENTER on the remote controller. Connection and setting of the unit is now complete.

#### Audio output of connected players

To enjoy digital surround sound including Dolby Digital and DTS, audio output should be set to "Bitstream output" on the connected Blu-ray Disc Player or other device. Depending on the settings on the Blu-ray Disc Player there may be cases when Dolby TrueHD, Dolby Atmos, and DTS-HD Master Audio audio is not output according to the format of the source. In this case, in the Blu-ray Disc Player settings try setting "BD video supplementary sound" (or secondary sound) to "Off". Change the listening mode after changing the setting to confirm.

# Step 3: Playing Back

## 1 Basic operations

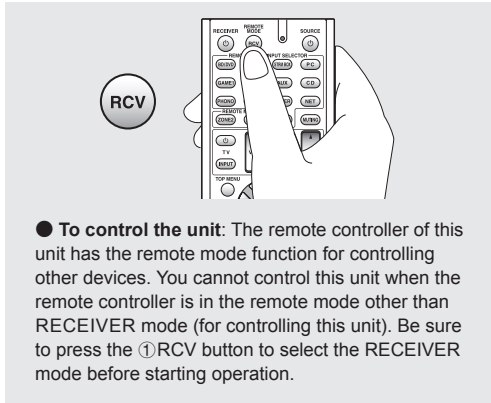

● **To control the unit:** The remote controller of this unit has the remote mode function for controlling other devices. You cannot control this unit when the remote controller is in the remote mode other than RECEIVER mode (for controlling this unit). Be sure to press the ① RCV button to select the RECEIVER mode before starting operation.

### 1. Turning the power on.

Press ② **RECEIVER** on the remote controller to turn the power on.

- Switch the input on the TV to that assigned to the unit. Use the TV's remote controller.

### 2. Select the input on the unit.

Press the ③ **INPUT SELECTOR** button with the same name as the jack used for connection. For example, press the BD/DVD button to play the player connected to the BD/DVD jack. Press TV to listen the TV's sound.

- Input will automatically be selected if the TV or player is CEC compliant and connected to the unit with HDMI cable.

### 3. Select the desired listening mode.

After pressing ① RCV, press the ⑦ listening mode buttons to switch the mode so that you can enjoy different listening modes.

### 4. Adjust the volume with ⑩ VOL.

## Remote controller parts name

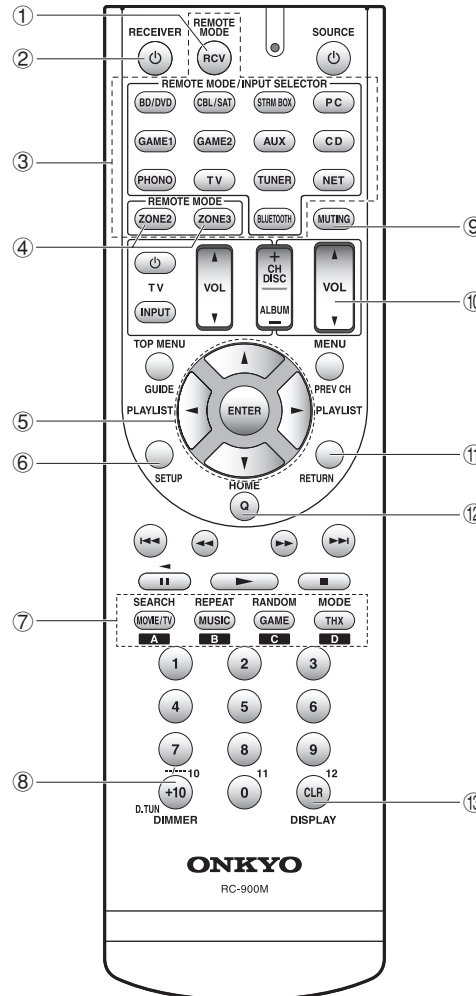

- ① **RCV button:** Switches the remote controller to the mode for operating this unit.
- ② **RECEIVER button:** Turns the unit on or into standby mode.
- ③ **REMOTE MODE/INPUT SELECTOR buttons:** Switches the input to be played. Each button is assigned to the following jacks.

Button	Jack	Button	Jack
BD/DVD	BD/DVD	GAME 2	GAME 2
CBL/SAT	CBL/SAT	AUX	AUX
STRM BOX	STRM BOX	CD	CD
PC	PC	PHONO	PHONO
GAME 1	GAME 1	TV	TV

- Use the TUNER button for AM/FM radio, the NET button for network features such as Internet radio and USB playback, and the button for BLUETOOTH features.

- After registering a particular remote control code to a button, you can switch the remote control mode to operate other equipment by pressing that button.

- ④ **ZONE2, ZONE3 buttons:** For use when the unit is connected with a pre-main amplifier and speakers in a separate room and sound is played there.
- ⑤ **Cursor buttons and ENTER button:** Moves the cursor and confirms the selection.
- ⑥ **SETUP button:** Displays the screen for making various settings for this unit.
- ⑦ **Listening mode buttons:** Allows you to select the listening mode.
  - MOVIE/TV button:** You can select a listening mode suitable for movies and TV programs.
  - MUSIC button:** You can select a listening mode suitable for music.
  - GAME button:** You can select a listening mode suitable for games.
  - THX button:** You can select a THX listening mode.
    - For details on the listening modes, see the Advanced Manual.
- ⑧ **DIMMER button:** Switches the brightness of the display.



- ⑨ **MUTING button:** Temporarily mutes audio. Press again to cancel muting.
- ⑩ **VOLUME buttons:** Allows you to adjust the volume. This button also cancels the muting.
- ⑪ **RETURN button:** Returns the display to the previous state.
- ⑫ **Q button:** Displays the Quick Setup menu that allows you to quickly access the frequently used setting items including sound quality adjustment.
- ⑬ **DISPLAY button:** Switches the information on the display.

## 2 Network Functions

You can enjoy sources such as Internet radio by connecting the unit to a network. For details on the operation, see the Advanced Manual.

- The operations described in this section are not displayed on the TV when the OSD (the feature to show information such as setting menus on the TV) language is set to "Chinese". Operate by confirming the display on the main unit. (European, Australian and Asian models)

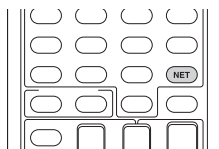

Press NET on the remote controller to display the NET TOP screen on the TV. Select the item with the cursors of the remote controller and press ENTER to confirm your selection. To return to the previous screen, press RETURN.

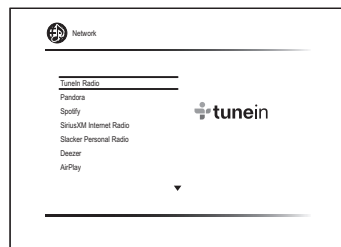

### Internet Radio services

The unit comes preset with Internet radio services such as TuneIn Radio. After selecting the desired service, follow the on-screen instructions, using the cursors to select radio stations and programs, then press ENTER to play.

- Network services or contents may become unavailable if the service provider terminates its service.
- Available services may vary depending on your area of residence.

### DLNA

You can play music files stored in the PC or NAS device connected to the network. Select the server with the cursors, select the desired music file and press ENTER to start playback.

- This unit needs to be connected to the same router as a computer or NAS device.

### Home media

You can play music files in a shared folder on the PC or NAS device connected to the network. Select the server with the cursors, select the desired music file and press ENTER to start playback.

- This unit needs to be connected to the same router as a computer or NAS device.

### USB

Play music files on a USB storage device. Connect the USB storage device to the USB jack on the rear of the unit, select the desired folder or music file with the cursors, and press ENTER to confirm and start playback.

## 3 AirPlay®

You can enjoy the audio from iPhone®, iPod touch®, iPad® and PCs with iTunes.

**Important:** The iOS device or PC needs to be connected to the network through the same router as this unit.

### ■ Playing music files from an iPhone, iPod touch, or iPad

Update the OS version on your iOS device to the latest version before connecting it to this unit.

1. Press NET on the remote controller.
2. Tap the AirPlay icon on the iPhone, iPod touch, or iPad, select this unit from the list of devices displayed, and click "Done".



- The AirPlay icon is displayed in the control center under iOS 7 and later. To display the control center, swipe from the bottom of the screen of the iOS device.
- If the AirPlay icon is not displayed, confirm that this unit and the iOS device are both connected to the router correctly.

3. Playing music files from an iPhone, iPod touch, or iPad.

### ■ Playing music files from a computer

- AirPlay is compatible with iTunes 10.2 or later.

1. Press NET on the remote controller.
2. Switch on your computer and start iTunes.

3. Click the AirPlay icon in iTunes and select this unit from the list of devices displayed.

4. Playing iTunes music files.

- If "6. Hardware"->"Power Management"->"Network Standby" is set to "On" in the Setup menu, then once AirPlay starts, this unit switches on automatically and the "NET" input source can be selected. Even if this setting is "Off", if the unit is already on then the "NET" input source can be selected.
- Information such as the name of the track is displayed on the unit's display during AirPlay playback.
- Due to the characteristics of AirPlay wireless technology, the sound produced on this unit may slightly be behind the sound played on the AirPlay-enabled device.
- There may be some differences in how operations are performed depending on the iOS or iTunes version.
- OSD are not displayed when the OSD language is set to "Chinese". Operate by confirming the display on the main unit. (European, Australian and Asian models)

**Volume:** The volume of this unit and the AirPlay-enabled device are linked. Take care that the volume doesn't become too loud when you adjust the volume on the AirPlay-enabled device. You may damage the unit or the speakers. Stop play on the AirPlay-enabled device immediately if the volume becomes too loud at any point.

## 4 BLUETOOTH® function

You can wirelessly enjoy music files stored in a smartphone or other BLUETOOTH enabled device. The coverage area is 48 feet (15 meters).

- Note that connection is not always guaranteed with all BLUETOOTH enabled devices.

### ■ Pairing

Pairing is necessary when connecting the BLUETOOTH enabled devices for the first time. Before starting the

procedure, learn how to enable the BLUETOOTH setting function and to connect with other devices on the BLUETOOTH enabled device.

1. Press BLUETOOTH on the remote controller.

The unit begins pairing and "Now Pairing..." is displayed.

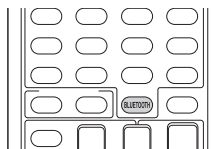

2. While "Now Pairing..." is on the display, complete connection on the BLUETOOTH enabled device in the nearby area within about 2 minutes.

If the name of this unit is displayed on the BLUETOOTH enabled device's display, select this unit. Pairing will end after a short time.

- If a password is requested, enter "0000".
- You can pair with another BLUETOOTH enabled device by pressing and holding the BLUETOOTH button while "Now Pairing..." is on the display. This unit can store the data of up to eight paired devices.

### ■ Playing BLUETOOTH enabled devices

If the unit is on and the BLUETOOTH enabled device is connected, the input will be automatically switched to BLUETOOTH. Play music in this state.

- It may take about a minute until connection is established when the unit is on since the BLUETOOTH function takes some time to start up.
- If the volume setting on the BLUETOOTH enabled device is low, the sound will not be output from this unit.
- Due to the characteristics of BLUETOOTH wireless technology, the sound produced on this unit may slightly be behind the sound played on the BLUETOOTH enabled device.
- OSD are not displayed when the OSD language is set to "Chinese". Operate by confirming the display on the main unit. (European, Australian and Asian models)

## 5 AM/FM Radio

The Basic Manual explains the method using automatic tuning. For manual tuning, see the Advanced Manual.

1. Press the TUN button on the main unit several times to select either "AM" or "FM".

2. Press TUNING MODE on the unit, so that the "AUTO" indicator on the display lights.

3. Press TUNING▲▲ on the unit.

The automatic tuning to a radio station starts. Searching stops when one is tuned. When tuned into a radio station, the "▶TUNED◀" indicator on the display lights. The "FM STEREO" indicator lights if the radio station is an FM radio station.

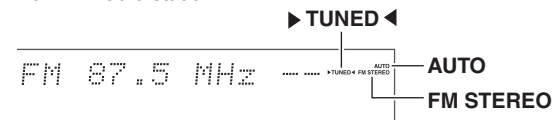

Actual display varies depending on the country or region

**Registering a radio station:** You can register up to 40 of your favorite AM/FM radio stations.

1. Tune into the AM/FM radio station you want to register.
  2. Press MEMORY on the unit so that the preset number on the display flashes.
  3. Repeatedly press PRESET◀▶ on the unit to select a number between 1 and 40 while the preset number is flashing (about 8 seconds).
  4. Press MEMORY again on the main unit to register the station. When registered, the preset number stops flashing. To select a preset radio station, press PRESET◀▶ on the main unit or CH +/- on the remote controller.
- To delete a registered preset station, press the PRESET◀▶ button on the main unit, select the preset number you want to delete, then while holding down the MEMORY button, press the TUNING MODE button. When deleted, the number on the display goes off.

**AM/FM frequency step setting**

It may be necessary for you to change the frequency step to tune the radio in your area. Change the step with the following procedure. Note that when this setting is changed, all radio presets are deleted.

- 1 After pressing RCV on the remote controller, press SETUP.
- 2 Select "6. Hardware" with the cursor and press ENTER.
- 3 Select "Tuner" with the cursor and press ENTER.
- 4 Select "AM/FM Frequency Step" (North American models) or "AM Frequency Step" (European, Australian and Asian models) with the cursor and select the frequency step for your area.

## 6 Multi-zone

You can listen to audio in a room (called Zone 2 or Zone 3) other than the one where this unit is located (called the main room). You can also output video and audio to a TV in the separate room (Zone 2) via HDMI.

**Sources you can playback**

- External players (\*1)
- NET (\*2)
- BLUETOOTH
- AM/FM Radio

- \*1 In Zone 2, you can play equipment connected to any of the HDMI IN1 to IN5 jacks, DIGITAL IN COAXIAL/OPTICAL jacks, or AUDIO IN jacks. Note that only analog or 2-channel PCM audio signals can be played and that some players require audio output setting. Only players connected to the AUDIO IN jack by analog connection can be played in Zone 3.
- \*2 DSD and Dolby TrueHD audio cannot be played in Zone 2/Zone 3.

**Making Multi-zone Connection**

There are the following three methods of connection.

- Connecting a TV in a separate room
- Connecting with an integrated amplifier or power amplifier in a separate room
- Connecting with speakers in a separate room

**a. Connecting a TV in a separate room**

You can play video and audio of the HDMI connected player on the TV in a separate room. With an HDMI cable, connect between the HDMI OUT SUB/ZONE 2 jack of the unit and the HDMI IN jack of the TV in a separate room.

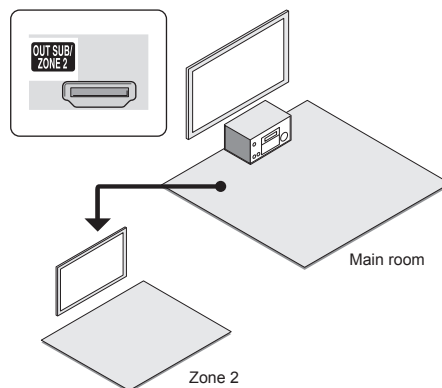

**Settings are required:** Press RCV and then SETUP on the remote controller, select "1. Input/Output Assign" - "TV Out" and set the "Zone 2 HDMI" setting to "Use".

- The information for a connected device can be displayed on the TV screen in a separate room. Press the ZONE2 button on the remote controller to select Zone 2 and press DISPLAY.
- Adjust the volume on the TV in the separate room.

**b. Connecting with an integrated amplifier or power amplifier in a separate room**

It is possible to play 2 ch source in a separate room while 7.1 ch source is being played in the main room. Connect the PRE/LINE OUT ZONE2 jacks or LINE OUT ZONE3 jacks of the unit and the line-in jacks of the integrated amplifier in a separate room with an RCA cable.

**Settings are required to listen to HDMI input audio in Zone 2:** Press RCV and then SETUP on the remote controller, select "1. Input/Output Assign" - "TV Out" and set the "Zone 2 HDMI" setting to "Use".

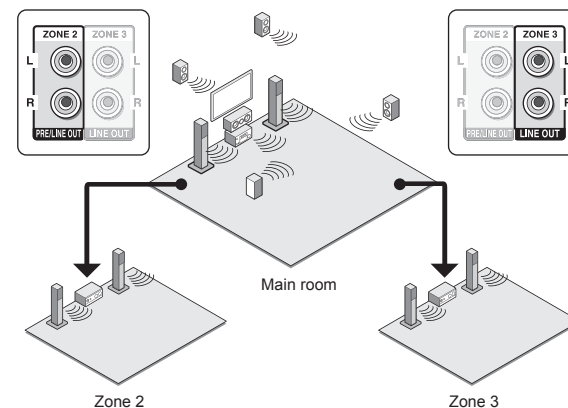

Zone 2 audio can be adjusted with both the unit and the pre-main amplifier used in the separate room. Zone 3 audio should be adjusted with the pre-main amplifier used in the separate room.

**Settings are required to adjust audio in Zone 2 using this unit:** Press RCV and then SETUP on the remote controller, select "3. Audio Adjust" - "Multi Zone" and set the "Zone 2 Out" setting to "Variable". Be sure to make this setting if you connect a power amplifier. If you do not, the volume output may be big enough to cause damage.

### ■ c. Connecting with speakers in another room

Connect the speakers in another room to the ZONE2 speaker terminals of the unit using speaker cables. Note that 5.1 ch will be the maximum (\*) in the main room during Zone 2 playback. No sound will be output from the back speakers and height speakers.

\* In this case, the Dolby Atmos listening mode cannot be selected.

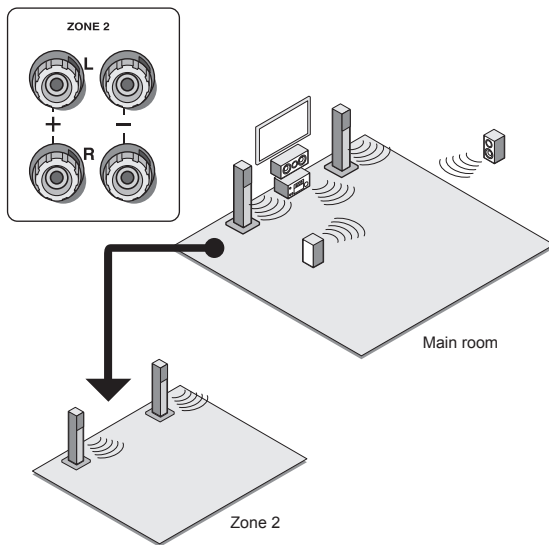

**These settings are required:** After connecting the speakers, press RCV and then SETUP on the remote controller, select "2. Speaker" - "Configuration" and set "Powered Zone 2" to "Yes".

**Settings are required to listen to HDMI input audio in Zone 2:** Press RCV and then SETUP on the remote controller, select "1. Input/Output Assign" - "TV Out" and set the "Zone 2 HDMI" setting to "Use".

### Performing Multi-zone Playback

It is possible to perform playback in the main room and a separate room at the same time, for example by playing the Blu-ray Disc player in the main room where the unit is placed while playing Internet radio in a separate room. It is also possible to perform playback only in a separate room.

- With external players, it is possible to play the same source or different sources in the main room and separate room.
- With "NET" and "BLUETOOTH", you cannot select different inputs for the main room and separate room. For example, if "NET" has been selected in the main room and then "BLUETOOTH" is selected as playback source in the separate room, the input in the main room will change to "BLUETOOTH" accordingly. Furthermore, you cannot select separate network services for the main room and a separate room with the "NET" input.
- When listening to AM/FM broadcasting, you cannot select different stations for the main room and separate room. Therefore broadcasting of the same station will be heard in the both rooms.
- If you have connected the same player by HDMI in the main room and in a separate room, input to this unit (the main room) will be 2-channel PCM.

### Playing Back

1. **Press ZONE2 or ZONE3 on the remote controller, point the remote controller at the main unit and press ◊RECEIVER.** "Z2" or "Z3" lights on the main unit display and the multi-zone function is enabled. (Zone 2 or Zone 3 is now on.)

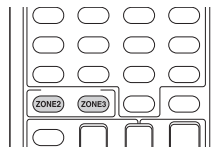

2. **Press ZONE2 or ZONE3 again on the remote controller and press INPUT SELECTOR of the input to be played in a separate room.**
  - If you turn the unit to standby during multi-zone playback, the Z2/Z3 indicators are dimmed and the

playback mode is switched to playback in a separate room only. Performing steps 1 and 2 while the unit is in standby also switches the playback mode to playback in a separate room only. To play the same source in the main room and separate room, hold down ZONE2 or ZONE3 for approximately 3 seconds.

**To control on the main unit:** press ZONE2 or ZONE3 and within 8 seconds, press the input selector button of the source to be played in the other room. To play the same source in the main room and separate room, press ZONE2 or ZONE3 twice.

### To adjust the audio in Zone 2

To adjust the volume, press ZONE2 on the remote controller and then adjust with VOL▲/▼. You can also temporarily mute sound by pressing MUTING. To control on the main unit, press ZONE2 and within 8 seconds, adjust with the MASTER VOLUME control.

To adjust the sound quality, press ZONE2 on the main unit and press TONE several times to display "Bass", "Treble" or "Balance" on the main unit display, then turn the dial to adjust.

### To turn off the function

After pressing ZONE2 or ZONE3 on the remote controller, press ◊RECEIVER. To control on the main unit, press ZONE2 or ZONE3 and press ◊ON/STANDBY.

- Power consumption in standby mode increases when the multi-zone function is being used.
- If Zone 2 or Zone 3 is turned on when the listening mode of the main room is Pure Audio, it will automatically switch to the Direct listening mode.
- While using the multi-zone function, the RI linked system function (link between Onkyo components) is disabled.
- Pressing INPUT SELECTOR on the remote controller while you are using the remote controller for Zone 2 or Zone 3 will switch the controlled target to the main room. To control Zone 2 or Zone 3 again, press the ZONE2 or ZONE3 button to enter the Zone control mode.

**WHOLE HOUSE MODE:** If you press WHOLE HOUSE MODE while playback is being performed in the main room, the WHOLE HOUSE MODE is turned on, "Z2" and "Z3" on the display light at the same time and the playback sources of all the rooms are switched to the same source at once.

- The sources that can be played in Zone 2 can be played in all rooms.
- This function cannot be used if headphones are connected or audio is output from the speakers of the TV.

## 7 Quick Setup menu

You can perform common settings on the television screen while playing.

### 1. Press Q on the remote controller.

The Quick Setup menu is displayed on the connected TV's screen.



### 2. Select the items with the cursors on the remote controller and then press ENTER.

- To return to the previous screen, press RETURN.

### 3. Select the content with the cursors of the remote controller.

■ **Listening Mode:** Select the listening mode from the categories of "MOVIE/TV", "MUSIC", "GAME" and "THX". After selecting, press ENTER button to confirm.

- It cannot be set when audio is played from the TV's speakers.

■ **Audio:** You can perform various audio settings including audio quality and speaker level adjustment.

- You cannot select this item when audio is output from the TV's speakers.

**Bass, Treble:** Adjust volume of the front speaker.

- It cannot be set if the listening mode is Pure Audio, Direct or THX.

**Phase Matching Bass:** Suppress phase shift in the midrange to enhance bass sound. Thus smooth and powerful bass sound can be obtained.

- It cannot be set if the listening mode is Pure Audio, Direct or THX.

**Center Level, Subwoofer Level:** Adjust the speaker level while listening to the sound. The adjustment you made will be reset to the previous status when you turn the unit to standby mode.

- Changes may not be possible depending on the speaker settings.
- This setting is not possible during MUTING or when using headphones.

**Speaker Layout:** Select the speakers to prioritize when back speakers and height speakers are connected at the same time.

- Changes may not be possible depending on the speaker settings.

**A/V Sync:** If the video is behind the audio, you can delay the audio to offset the gap. Different settings can be set for each input selector.

- It cannot be set if the listening mode is Pure Audio or Direct.

**AccuEQ Room Calibration:** Enable or disable the settings made by automatic speaker setting. If this is to be enabled, then normally you should select "On (All Ch)", and to disable just the front speakers you should select "On (ex. L/R)". The setting can be separately set to each input selector.

- This setting cannot be selected if the automatic speaker setting has not been performed.
- It cannot be set if headphones are connected or the listening mode is Pure Audio or Direct.

**Equalizer:** Select "Preset1" to "Preset3" configured in "2. Speaker" - "Equalizer Settings" in the Setup menu. The same sound field setting is applied all ranges when set to "Off".

- It cannot be set if the listening mode is Pure Audio or Direct.

**Music Optimizer:** Improve the quality of the compressed audio. Playback sound of lossy compressed files such as MP3 will be improved. The setting can be separately set to each input selector.

- The setting is effective in the signals of 48 kHz or less. The setting is not effective in the bitstream signals.
- It cannot be set if the listening mode is Pure Audio or Direct.

**Late Night:** Make small sounds to be easily heard. It is useful when you need to reduce the volume while watching a movie late night. You can enjoy the effect only with Dolby Digital, Dolby Digital Plus, Dolby TrueHD, and DTS sources.

- Turning the unit to standby mode will set the setting to "Off". In case of Dolby TrueHD, the setting will be set to "Auto".
- The setting cannot be used in the following cases.
  - If "3. Audio Adjust" - "Dolby" - "Loudness Management" in the Setup menu is set to "Off" when playing Dolby Digital Plus or Dolby TrueHD
  - When the input signal is DTS and "Dialog Control" is other than 0 dB

**Re-EQ, Re-EQ(THX):** Adjust the soundtrack that was processed to enhance its treble, in order to make it suitable for home theater.

- This function can be used in the following listening modes: Dolby Digital, Dolby Digital Plus, Dolby TrueHD, Multichannel, DTS, DTS-ES, DTS 96/24, DTS-HD High Resolution Audio, DTS-HD Master Audio, and DTS Express.
- In Re-EQ(THX), the following listening modes can be used: THX Cinema, THX Surround EX, and THX Select2 Cinema.

**Center Spread:** Adjust the width of the sound field of the front channel when playing in the Dolby Surround listening mode.

To spread the width of the sound field to the left and right, set to "On". To concentrate sound in the center, set to "Off".

- Depending on the speaker settings, this becomes "Off".

**Dialog Control:** You can increase the dialog portion of the audio in 1 dB steps up to 6 dB so that you can make dialog easier to hear over background noise.

- This cannot be set for content other than DTS:X.
- The effect may not be selectable with some content.

#### ■ HDMI :

**HDMI OUT:** Select the HDMI OUT jack to be used for output.

**Control TV:** Set whether to enable the CEC link function for TVs connected through one of the HDMI OUT MAIN or SUB jacks.

#### ■ Information:

**Audio:** Displays the audio input source, format, number of channels, sampling frequency, listening mode, and number of output channels.

**Video:** Displays information such as the video input source, resolution, color space, color depth, 3D information, aspect ratio, and output.

**Tuner:** Displays information such as the band, frequency, and preset number. This is displayed only when "TUNER" is selected as the input source.

## 8 Other useful functions

### To adjust the sound quality

It is possible to enhance or moderate the bass and treble of front speakers. Press TONE on the main unit several times to select the desired setting from "Bass", "Treble" and "Phase Matching Bass", and turn the TONE dial to adjust.

- This cannot be set if the listening mode is Pure Audio,

Direct, or THX.

**"Bass":** Allows you to enhance or moderate the bass.

**"Treble":** Allows you to enhance or moderate the treble.

**"Phase Matching Bass":** Allows you to keep the clear midrange and effectively enhance the bass.

### Checking the Input Format

Press DISPLAY on the remote controller several times to switch the display of the main unit in order of:

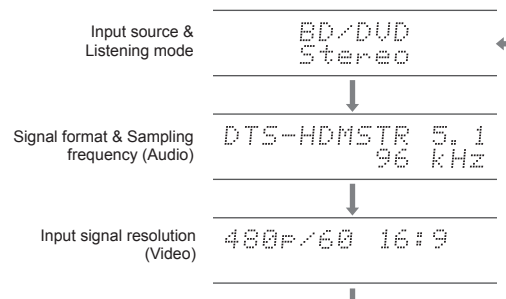

- If "Dolby D 5.1" is displayed in Signal format, the Dolby Digital 5.1 ch signals are being input. When listening to AM/FM radio, the band, frequency and preset number are displayed.

### Playing Audio and Video from Separate Sources

It is possible to play audio and video from different sources. For example, you can play audio from the CD player and video from the BD/DVD player. In this case, press BD/DVD on the remote controller and then CD. Then start playback on the BD/DVD player and CD player. This function is effective when an input with audio only has been selected (CD, NET, BLUETOOTH, TUNER, and PHONO in the initial setting). (※)

- ※ When NET or BLUETOOTH is selected, press either the NET or BLUETOOTH button then press MODE on the remote controller.

## Troubleshooting

### Before starting the procedure

Problems may be solved by simply turning the power on/off or disconnecting/connecting the power cord, which is easier than working on the connection, setting and operating procedure. Try the simple measures on both the unit and the connected device. If the problem is that the video or audio is not output or the HDMI linked operation does not work, disconnecting/connecting the HDMI cable may solve it. When reconnecting, be careful not to wind the HDMI cable since if wound the HDMI cable may not fit well. After reconnecting, turn off and on the unit and the connected device.

### The AV receiver turns off unexpectedly.

- The AV receiver will automatically enter standby mode when Auto Standby or Sleep Timer is set and launched.
- The protective circuit function may have been activated. If this has occurred, "AMP Diag Mode" appears on the display when the unit is turned on again, and the unit enters diagnostic mode. If the results of the diagnosis is that there is no problem, the "AMP Diag Mode" display disappears and you can use the unit normally again. If "CHECK SP WIRE" appears on the display, the speaker cables may be short-circuited. Make sure bare speaker wires are not touching each other or the back panel of the unit, then turn the unit on again. If "NG" is displayed, immediately unplug the power cord from the wall outlet and contact your Onkyo dealer.

### There's no sound, or it's very quiet.

- A wrong input selector button has been selected. Select a correct input for the player. Also check that muting is not on.
- Not all listening modes use all speakers.

### There's no picture.

- A wrong input selector button has been selected.
- Video input through analog jacks is not displayed if the listening mode is Pure Audio.
- To display video from the connected player on the TV screen while the unit is in standby, you need to enable HDMI Standby Through function.
- When the TV image is blurry or unclear, power code or

connection cables of the unit may have interfered. In that case, keep distance between TV antenna cable and cables of the unit.

- If you connect a player supporting HDCP2.2, be sure to connect it to one of the HDMI IN1 to IN5 jacks of the unit.

### Video and audio are out of synch

- Video may be delayed relative to audio depending on the settings and connections with your television. Adjust in "Step 3: Playing Back", "7 Quick Setup menu", "A/V Sync".

### Cannot play digital surround

- To enjoy digital surround sound including Dolby Digital and DTS, audio output should be set to "Bitstream output" on the connected Blu-ray Disc Player or other device.

### Cannot output audio such as Dolby Atmos according to the format of the source.

- If you cannot output formats such as Dolby TrueHD, Dolby Atmos, or DTS-HD Master Audio according to the format of the source, in the Blu-ray Disc Player settings try setting "BD video supplementary sound" (or secondary sound) to "Off". Change the listening mode for each source after changing the setting to confirm.

### HDMI control does not function correctly.

- Set the CEC link function of the unit to on. It is also necessary to make the HDMI linked system setting on the TV. See the TV's instruction manual for details.

### Cannot access to network.

- Try plugging/unplugging the unit or the wireless LAN router or check their power-on status. This will work well in many cases.
- If the desired wireless LAN router is not in the access point list, it may be set to hide SSID or the ANY connection may be off. Change the setting and try again.

## Resetting the unit

Resetting the unit to the status at the time of shipment may solve the problem. If the measures above do not solve the problem, reset the unit with the following procedure. If you reset the unit status, your preferences will be reset to the defaults. Note them down before starting reset.

### How to reset:

1. While holding down CBL on the main unit (note that step 2 must be performed with this button pressed down)
2. Press **ON/STANDBY** on the main unit ("Clear" appears on the display and the unit returns to standby)
  - Do not unplug the power cord until "Clear" disappears from the display.

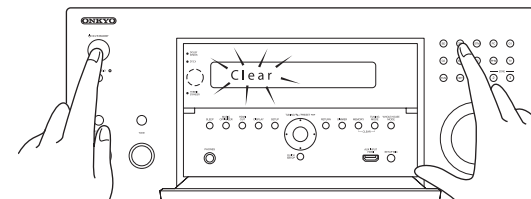

2. Press **ON/STANDBY**.

1. While holding down the CBL button

### How to reset the remote controller:

1. While holding down RCV on the remote controller, press **Q** until the remote indicator stays lit (about 3 seconds).
2. Within 30 seconds, press RCV again.

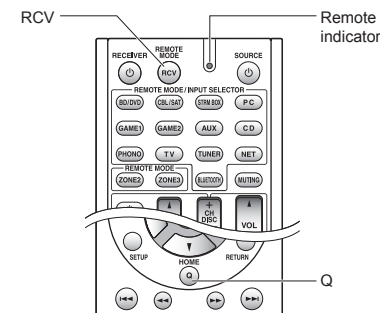





## Table of image resolutions

Refer to the following table for information about the image formats and resolutions output by this unit in response to input signals

Input \ Output		HDMI						
		4K	1080p/24	1080p	1080i	720p	480p/576p	480i/576i
HDMI	4K	✓						
	1080p/24		✓					
	1080p			✓				
	1080i				✓			
	720p					✓		
	480p/576p						✓	
	480i/576i							✓
Component	1080p							
	1080i							
	720p							
	480p/576p							
Composite	480i/576i							✓
	480i/576i							✓

## Resolutions supported by HDMI

### ■ HDMI IN1 to IN5 (when using in the main room)

Copyright protection technology	Display resolution	Frame rate	Color space	Color Depth	Remarks	
HDCP1.4 HDCP2.2	720 × 480i	60 Hz	RGB/YCbCr4:4:4/ YCbCr4:2:2	8/10/12/16 bit	With YCbCr4:2:2, only 12 bit Color Depth is supported.	
	720 × 576i	50 Hz				
	720 × 480p	60 Hz				
	720 × 576p	50 Hz				
	1920 × 1080i	50/60 Hz				
	1280 × 720p	24/25/30/50/60 Hz				
	1680 × 720p	24/25/30/50/60 Hz				
	1920 × 1080p	24/25/30/50/60 Hz				
	2560 × 1080p	24/25/30 Hz				8 bit
						12 bit
		50/60 Hz				8 bit
						12 bit
	4K (3840 × 2160p)	24/25/30 Hz				8 bit
						12 bit
		50/60 Hz				8 bit
						12 bit
4K SMPTE (4096 × 2160p)		24/25/30 Hz	8 bit			
			12 bit			
	50/60 Hz	8 bit				
		12 bit				

### ■ HDMI IN1 to IN5 (when using in Zone 2)

Copyright protection technology	Display resolution	Frame rate	Color space	Color Depth	Remarks	
HDCP1.4 HDCP2.2	720 × 480i	60 Hz	RGB/YCbCr4:4:4/ YCbCr4:2:2	8/10/12/16 bit	With YCbCr4:2:2, only 12 bit Color Depth is supported.	
	720 × 576i	50 Hz				
	720 × 480p	60 Hz				
	720 × 576p	50 Hz				
	1920 × 1080i	50/60 Hz				
	1280 × 720p	24/25/30/50/60 Hz				
	1680 × 720p	24/25/30/50/60 Hz				
	1920 × 1080p	24/25/30/50/60 Hz				
	2560 × 1080p	24/25/30 Hz				8 bit
						12 bit
	4K (3840 × 2160p)	24/25/30 Hz				8 bit
						12 bit
		50/60 Hz				8 bit
						12 bit
	4K SMPTE (4096 × 2160p)	24/25/30 Hz				8 bit
						12 bit
50/60 Hz		8 bit				
		12 bit				

### ■ HDMI IN6, IN7, Front

Copyright protection technology	Display resolution	Frame rate	Color space	Color Depth	Remarks	
HDCP1.4	720 × 480i	60 Hz	RGB/YCbCr4:4:4/ YCbCr4:2:2	8/10/12/16 bit	With YCbCr4:2:2, only 12 bit Color Depth is supported.	
	720 × 576i	50 Hz				
	720 × 480p	60 Hz				
	720 × 576p	50 Hz				
	1920 × 1080i	50/60 Hz				
	1280 × 720p	24/25/30/50/60 Hz				
	1680 × 720p	24/25/30/50/60 Hz				
	1920 × 1080p	24/25/30/50/60 Hz				
	2560 × 1080p	24/25/30 Hz				8 bit
						12 bit
	4K (3840 × 2160p)	24/25/30 Hz				8 bit
						12 bit
		50/60 Hz				8 bit
						12 bit
	4K SMPTE (4096 × 2160p)	24/25/30 Hz				8 bit
						12 bit
50/60 Hz		8 bit				
		12 bit				

## Precautions

### For U.S. Models

#### FEDERAL COMMUNICATIONS COMMISSION DECLARATION OF CONFORMITY

This device complies with part 15 of the FCC Rules. Operation is subject to the following two conditions:

- (1) this device may not cause interference, and
- (2) this device must accept any interference, including interference that may cause undesired operation of the device.

Product Name: AV Receiver  
 Model Number: TX-RZ900/TX-RZ800  
 Responsible Party Name: Onkyo U.S.A. Corporation  
 Address: 18 PARK WAY, UPPER SADDLE RIVER,  
 NEW JERSEY 07458, USA  
 Phone: 1-800-229-1687

### For European Models

#### Declaration of Conformity

We declare, under our sole responsibility, that this product complies with the standards:

- Safety
  - Limits and methods of measurement of radio disturbance characteristics
  - Limits for harmonic current emissions
  - Limitation of voltage changes, voltage fluctuations and flicker
  - RoHS Directive, 2011/65/EU
- Hereby, Onkyo Corporation, declares that this TX-RZ900/TX-RZ800 is in compliance with the essential requirements and other relevant provisions of Directive 1999/5/EC.
- С настоящето, Onkyo Corporation, декларира, че TX-RZ900/TX-RZ800 е в съответствие със съществените изисквания и другите приложими разпоредби на Директива 1999/5/EC.
- Onkyo Corporation tímto prohlašuje, že TX-RZ900/TX-RZ800 splňuje základní požadavky a všechna příslušná ustanovení Směrnice 1999/5/ES.
- Undertegnede Onkyo Corporation erklærer herved, at følgende udstyr TX-RZ900/TX-RZ800 overholder de væsentlige krav og øvrige relevante krav i direktiv 1999/5/EF.
- Hiermit erklärt Onkyo Corporation, dass sich das Gerät TX-RZ900/TX-RZ800 in Übereinstimmung mit den grundlegenden Anforderungen und den übrigen einschlägigen Bestimmungen der Richtlinie 1999/5/EG befindet.
- Käesolevaga kinnitab Onkyo Corporation seadme TX-RZ900/TX-RZ800 vastavust direktiivi 1999/5/EÜ põhinõuetele ja nimetatud direktiivist tulenevatele teistele asjakohastele sätetele.
- ΜΕ ΤΗΝ ΠΑΡΟΥΣΑ Ο ΚΑΤΑΣΚΕΥΑΣΤΗΣ Onkyo Corporation ΔΗΛΩΝΕΙ ΟΤΙ ΤΟ TX-RZ900/TX-RZ800 ΣΥΜΜΟΡΦΟΝΕΤΑΙ ΠΡΟΣ ΤΙΣ ΟΥΣΙΩΔΕΙΣ ΑΠΑΙΤΗΣΕΙΣ ΚΑΙ ΤΙΣ ΛΟΙΠΕΣ ΣΧΕΤΙΚΕΣ ΔΙΑΤΑΞΕΙΣ ΤΗΣ ΟΔΗΓΙΑΣ 1999/5/ΕΚ
- Por la presente, Onkyo Corporation, declara que este TX-RZ900/TX-RZ800 cumple con los requisitos esenciales y otras exigencias relevantes de la Directiva 1999/5/EC.



- Par la présente, Onkyo Corporation déclare que l'appareil TX-RZ900/TX-RZ800 est conforme aux exigences essentielles et aux autres dispositions pertinentes de la directive 1999/5/CE.
- Con la presente Onkyo Corporation dichiara che questo TX-RZ900/TX-RZ800 è conforme ai requisiti essenziali ed alle altre disposizioni pertinenti stabilite dalla direttiva 1999/5/CE.
- Ar šo Onkyo Corporation deklarē, ka TX-RZ900/TX-RZ800 atbilst Direktīvas 1999/5/EK būtiskajām prasībām un citiem ar to saistītajiem noteikumiem.
- Šiuo Onkyo Corporation deklaruoja, kad šis TX-RZ900/TX-RZ800 atitinka esminius reikalavimus ir kitas 1999/5/EB Direktyvos nuostatas.
- A Onkyo Corporation ezzennel kijelentli, hogy a TX-RZ900/TX-RZ800 típusú berendezés teljesíti az alapelvető követelményeket és más 1999/5/EK irányelvben meghatározott vonatkozó rendelkezéseket.
- Hierbij verklaart Onkyo Corporation dat het toestel TX-RZ900/TX-RZ800 in overeenstemming is met de essentiële eisen en de andere relevante bepalingen van richtlijn 1999/5/EG.
- Niniejszym Onkyo Corporation deklaruje że TX-RZ900/TX-RZ800 jest zgodny z zasadniczymi wymaganiami i innymi właściwymi postanowieniami Dyrektywy 1999/5/EC.
- Eu, Onkyo Corporation, declaro que o TX-RZ900/TX-RZ800 cumpre os requisitos essenciais e outras provisões relevantes da Directiva 1999/5/EC.
- Prin prezenta, Onkyo Corporation, declară că aparatul TX-RZ900/TX-RZ800 este în conformitate cu cerințele esențiale și cu alte prevederi pertinente ale Directivei 1999/5/CE.
- Onkyo Corporation týmto vyhlasuje, že TX-RZ900/TX-RZ800 a splňa základné požiadavky a všetky príslušné ustanovenia Smernice 1999/5/ES.
- Onkyo Corporation izjavlja, da je ta TX-RZ900/TX-RZ800 v skladu z bistvenimi zahtevami in drugimi relevantnimi določili direktive 1999/5/ES.
- Onkyo Corporation vakuuttaa täten että TX-RZ900/TX-RZ800 tyyppinen laite on direktiivin 1999/5/EY oleellisten vaatimusten ja sitä koskevien direktiivin muiden ehtojen mukainen.
- Härmed förklarar Onkyo Corporation att denna TX-RZ900/TX-RZ800 följer de väsentliga kraven och andra relevanta stadgar i Direktiv 1999/5/EC.
- Hér með lýsir Onkyo Corporation því yfir að varan TX-RZ900/TX-RZ800 er í samræmi við grunnkröfur og aðrar kröfur sem gerðar eru í tilskipun 1999/5/EC.
- Onkyo Corporation erklærer herved at denne TX-RZ900/TX-RZ800 er i overensstemmelse med væsentlige krav og andre relevante bestemmelser i direktiv 1999/5/EC.
- Ovime Onkyo Corporation, potvrđuje da je TX-RZ900/TX-RZ800 u suglasnosti sa osnovnim zahtjevima i ostalim relevantnim odredbama Direktive 1999/5/EC.

## License and Trademark Information



Manufactured under license from Dolby Laboratories. Dolby, Dolby Atmos, Dolby Surround, Surround EX and the double-D symbol are trademarks of Dolby Laboratories.



For DTS patents, see <http://patents.dts.com>. Manufactured under license from DTS, Inc. DTS, the Symbol, DTS in combination with the Symbol, the DTS-HD logo, and DTS-HD Master Audio are registered trademarks or trademarks of DTS, Inc. in the United States and/or other countries. © DTS, Inc. All Rights Reserved.



Manufactured under license from THX Ltd. THX and the THX logo are registered in the U.S. and other jurisdictions. All rights reserved. Surround EX is a trademark of Dolby Laboratories. Used with permission. U.S. Pat. nos. 7,254,239 & 7,593,533 & 7,974,425 & 8,452,028 & 8,509,457 Taiwan Pat. I238671 European Pat. 1,360,874

### THX Select2 Plus

Before any home theater component can be THX Select2 Plus certified, it must pass a rigorous series of quality and performance tests. Only then can a product feature the THX Select2 Plus logo, which is your guarantee that the Home Theater products you purchase will give you superb performance for many years to come. THX Select2 Plus requirements define hundreds of parameters, including power amplifier performance, and integrated amplifier performance and operation for both digital and analog domains. THX Select2 Plus receivers also feature proprietary THX technologies (e.g., THX Mode) which accurately translate movie soundtracks for home theater playback.

Re-Equalization and the "Re-EQ" logo are trademarks of THX Ltd.



The terms HDMI and HDMI High-Definition Multimedia Interface, and the HDMI Logo are trademarks or registered trademarks of HDMI Licensing LLC in the United States and other countries.



The Wi-Fi CERTIFIED Logo is a certification mark of the Wi-Fi Alliance®.



AirPlay, iPad, iPhone, and iPod touch are trademarks of Apple Inc., registered in the U.S. and other countries.



iPad Air and iPad mini are trademarks of Apple Inc.

"Made for iPod", "Made for iPhone" and "Made for iPad" mean that an electronic accessory has been designed to connect specifically to iPod, iPhone, or iPad, respectively, and has been certified by the developer to meet Apple performance standards. Apple is not responsible for the operation of this device or its compliance with safety and regulatory standards.

Please note that the use of this accessory with iPod, iPhone or iPad may affect wireless performance.

AirPlay works with iPhone, iPad, and iPod touch with iOS 4.3.3 or later, Mac with OS X Mountain Lion or later, and PC with iTunes 10.2.2 or later.

Apple, Apple TV and Safari are trademarks of Apple Inc., registered in the U.S. and other countries.



The BLUETOOTH® word mark and logos are registered trademarks owned by Bluetooth SIG, Inc. and any use of such marks by Onkyo Corporation is under license. Other trademarks and trade names are those of their respective owners.

Onkyo Corporation does not guarantee BLUETOOTH compatibility between the AV receiver and all BLUETOOTH enabled devices. For compatibility between the AV receiver and another device with BLUETOOTH technology, consult the device's documentation and dealer. In some countries, there may be restrictions on using BLUETOOTH devices. Check with your local authorities.



SIRIUS, XM and all related marks and logos are trademarks of Sirius XM Radio Inc. and its subsidiaries. All rights reserved.

DLNA®, the DLNA Logo and DLNA CERTIFIED® are trademarks, service marks, or certification marks of the Digital Living Network Alliance.

This product is protected by certain intellectual property rights of Microsoft. Use or distribution of such technology outside of this product is prohibited without a license from Microsoft.

Windows and the Windows logo are trademarks of the Microsoft group of companies.

QR Code is a registered trademark of DENSO WAVE INCORPORATED.

"x.v.Color" and "x.v.Color" logo are trademarks of Sony Corporation.

DSD and the Direct Stream Digital logo are trademarks of Sony Corporation.

MPEG Layer-3 audio coding technology licensed from Fraunhofer IIS and Thomson.

AccuEQ, Music Optimizer, RIHD and WRAT are trademarks of Onkyo Corporation.

"All other trademarks are the property of their respective owners."

## DISCLAIMER

Through this device you are able to link to other services or websites

which are not under the control of any company which has designed, manufactured or distributed/have distributed this device, and its affiliates (collectively, "Company"). We have no control over the nature, content and availability of those services. The inclusion of any links does not necessarily imply a recommendation or endorse the views expressed within them.

All information, content and services available through this device belong to third parties and are protected by copyright, patent, trademark and/or other intellectual property laws of applicable countries.

The information, content and services provided through this device are for your personal, noncommercial use only. Any information, content or services may not be used in any manner other than previously approved by the appropriate content owner or service provider.

You may not modify, copy, republish, translate, exploit, create derivative works, upload, post, transmit, sell or distribute in any manner any information, content or services available through this device, unless expressly permitted by the appropriate copyright, patent, trademark and/or other intellectual property owner, including, without limitation, content owner or service provider.

THE CONTENT AND SERVICES AVAILABLE THROUGH THIS DEVICE ARE PROVIDED "AS IS".

COMPANY DOES NOT WARRANT INFORMATION, CONTENT OR SERVICES SO PROVIDED, EITHER EXPRESSLY OR IMPLIEDLY, FOR ANY PURPOSE.

COMPANY EXPRESSLY DISCLAIMS ANY WARRANTIES, EXPRESS OR IMPLIED, INCLUDING BUT NOT LIMITED TO, WARRANTIES OF TITLE, NON-INFRINGEMENT, MERCHANTABILITY OR FITNESS FOR A PARTICULAR PURPOSE.

Company makes no representation or warranty of any kind, express or implied, about the completeness, accuracy, validity, legality, reliability, suitability or availability with respect to the information, content or services available through this device. Company shall not be liable, whether in contract or tort, including negligence and strict liability, for any direct, indirect, special, incidental or consequential damages or any other damages arising out of, or in connection with, any information contained in, or as a result of the use of any content or service by you or any third party, even if Company has been advised of the possibility of such damages, nor shall Company be liable for any third party claims against users of this device or any third party.

In no event shall Company be responsible nor liable for, without limiting the generality of the foregoing, any interruption or suspension of any information, content or service available through this device. Company is neither responsible nor liable for customer service related to the information, content and services available through this device. Any question or request for service relating to the information, content or services should be made directly to the appropriate content owners and services providers.



**COST OF ALL NECESSARY SERVICING, REPAIR OR CORRECTION.**  
**16. IN NO EVENT UNLESS REQUIRED BY APPLICABLE LAW OR AGREED TO IN WRITING WILL ANY COPYRIGHT HOLDER, OR ANY OTHER PARTY WHO MAY MODIFY AND/OR REDISTRIBUTE THE LIBRARY AS PERMITTED ABOVE, BE LIABLE TO YOU FOR DAMAGES, INCLUDING ANY GENERAL, SPECIAL, INCIDENTAL OR CONSEQUENTIAL DAMAGES ARISING OUT OF THE USE OR INABILITY TO USE THE LIBRARY (INCLUDING BUT NOT LIMITED TO LOSS OF DATA OR DATA BEING RENDERED INACCURATE OR LOSSES SUSTAINED BY YOU OR THIRD PARTIES OR A FAILURE OF THE LIBRARY TO OPERATE WITH ANY OTHER SOFTWARE), EVEN IF SUCH HOLDER OR OTHER PARTY HAS BEEN ADVISED OF THE POSSIBILITY OF SUCH DAMAGES.**

## END OF TERMS AND CONDITIONS

### How to Apply These Terms to Your New Libraries

If you develop a new library, and you want it to be of the greatest possible use to the public, we recommend making it free software that everyone can redistribute and change. You can do so by permitting redistribution under these terms (or, alternatively, under the terms of the ordinary General Public License).

To apply these terms, attach the following notices to the library. It is safest to attach them to each source file so most effectively convey the exclusion of warranty, and each file should have at least the "copyright" line and a pointer to where the full notice is found.

<one line to give the library's name and an idea of what it does >

Copyright (C) <year> <name of author>

This library is free software; you can redistribute it and/or modify it under the terms of the GNU Lesser General Public License as published by the Free Software Foundation; either version 2.1 of the License, or (at your option) any later version.

This library is distributed in the hope that it will be useful, but WITHOUT ANY WARRANTY; without even the implied warranty of MERCHANTABILITY or FITNESS FOR A PARTICULAR PURPOSE. See the GNU Lesser General Public License for more details.

You should have received a copy of the GNU Lesser General Public License along with this library; if not, write to the Free Software Foundation, Inc., 59 Temple Place, Suite 330, Boston, MA 02111-1307 USA  
 Also add information on how to contact you by electronic and paper mail.

You should also get your employer (if you work as a programmer) or your school, if any, to sign a "copyright disclaimer" for the library, if necessary. Here is a sample, alter the names:

Yoodyne, Inc., hereby disclaims all copyright interest in the library 'Frob' (a library for tweaking knobs) written by James Random Hacker.

signature of Ty Coon, 1 April 1990

Ty Coon, President of Vice

That's all there is to it.

GNU GENERAL PUBLIC LICENSE

Version 2, June 1991

Copyright (C) 1989, 1991 Free Software Foundation, Inc. 59 Temple Place - Suite 330, Boston, MA 02111-1307, USA

Everyone is permitted to copy and distribute verbatim copies of this license document, but changing it is not allowed.

Preamble

The licenses for most software are designed to take away your freedom to share and change it. By contrast, the GNU General Public License is intended to guarantee your freedom to share and change free software—to make sure the software is free for all its users. This General Public License applies to most of the Free Software Foundation's software and to any other program whose authors commit to using it. (Some other Free Software Foundation software is covered by the GNU Library General Public License instead.) You can apply it to your programs, too.

When we speak of free software, we are referring to freedom, not price. Our General Public Licenses are designed to make sure that you have the freedom to distribute copies of free software (and change for this service if you wish), that you receive source code or can get it if you want it, that you can change the software or use pieces of it in new free programs; and that you know you can do these things.

To protect your rights, we need to make restrictions that forbid anyone to deny you these rights or to ask you to surrender the rights. These restrictions translate to certain responsibilities for you if you distribute copies of the software, or if you modify it.

For example, if you distribute copies of such a program, whether gratis or for a fee, you must give the recipients all the rights that you have. You must make sure that they, too, receive or can get the source code. And you must show them these terms so they know their rights.

We protect your rights with two steps: (1) copyright the software, and (2) offer you this license which gives you legal permission to copy, distribute and/or modify the software.

Also, for each author's protection and ours, we want to make certain that everyone understands that there is no warranty for this free software. If the software is modified by someone else and passed on, we want its recipients to know that what they have is not the original, so that any problems introduced by others will not reflect on the original authors' reputations.

Finally, any free program is treated constantly by software patents. We wish to avoid the danger that redistributors of a free program will individually obtain patent licenses, in effect making the program proprietary. To prevent this, we have made it clear that any patent must be licensed for everyone's free use or not licensed at all.

The precise terms and conditions for copying, distribution and modification follow.

**TERMS AND CONDITIONS FOR COPYING, DISTRIBUTION AND MODIFICATION**

This license applies to any program or other work which contains a notice placed by the copyright holder saying it may be distributed under the terms of this General Public License. The "Program", below, refers to any such program or work, and a "work based on the Program" means either the Program or any derivative work under copyright law; that is to say, a work containing the Program or a portion of it, either verbatim or with modifications and/or translated into another language. (Hereinafter, translation is included without limitation in the term "modification".) Each license is addressed as "you".

Activities other than copying, distribution and modification are not covered by this License; they are outside its scope. The act of running the Program is not restricted, and the output from the Program is covered only if its contents constitute a work based on the Program (independent of having been made by running the Program). Whether that is true depends on what the Program does.

You may copy and distribute verbatim copies of the Program's source code as you receive it, in any medium, provided that you conspicuously and appropriately publish on each copy an appropriate copyright notice and disclaimer of warranty, keep intact all the notices that refer to this License and to the absence of any warranty; and give any other recipients of the Program a copy of this License along with the Program.

You may charge a fee for the physical act of transferring a copy, and you may at your option offer warranty protection in exchange for a fee.

You may modify your copy or copies of the Program or any portion of it, thus forming a work based on the Program, and copy and distribute such modifications or work under the terms of Section 1 above, provided that you also meet all of these conditions:

a) You must cause the modified files to carry prominent notices stating that you changed the files and the date of any change.

b) You must cause any work that you distribute or publish, that in whole or in part contains or is derived from the Program or any part thereof, to be licensed as a whole to all recipients under the terms of this License.

c) If the modified program normally reads commands interactively when run, you must cause it, when started running for such interactive use in the most ordinary way, to print or display an announcement including an appropriate copyright notice and a notice that there is no warranty (or, else, saying that you provide a warranty) and that users may redistribute the program under these conditions, and telling the user how to view a copy of this License. (Exception: If the Program itself is

interactive but does not normally print such an announcement, your work based on the Program is not required to print an announcement.)

These requirements apply to the modified work as a whole. If identifiable sections of that work are not derived from the Program, and can reasonably be considered independent and separate works in themselves, then this License, and its terms, do not apply to those sections when you distribute them as separate works. But when you distribute the same sections as part of a whole which is a work based on the Program, the distribution of the whole must be on the terms of this License, so permissions for other license holders to distribute the work must apply to the whole, and you must honor that other license to the extent that it does. Thus, it is not the intent of this section to claim rights or contest your rights to work written entirely by you; rather, the intent is to exercise the right to control the distribution of derivative or collective works based on the Program.

In addition, mere aggregation of another work not based on the Program with the Program (or with a work based on the Program) on a volume of a storage or distribution medium does not bring the other work under the scope of this License.

You may copy and distribute the Program (or a work based on it, under Section 2) in object code or executable form under the terms of Sections 1 and 2 above provided that you also do one of the following:

a) Accompany it with the complete corresponding machine-readable source code, which must be distributed under the terms of Sections 1 and 2 above on a medium customarily used for software interchange; or

b) Accompany it with a written offer, valid for at least three years, to give any third party, for a charge no more than your cost of physically performing source distribution, a complete machine-readable copy of the corresponding source code, to be distributed under the terms of Sections 1 and 2 above on a medium customarily used for software interchange; or,

c) Accompany it with the information you received to enable you to redistribute corresponding source code. (This alternative is allowed only for noncommercial distribution and only if you received the program in object code or executable form with such an offer, in accord with Subsection b) above.)

The source code for a work means the preferred form of the work for making modifications to it. For an executable work, complete source code means all the source code for all modules it contains, plus any associated interface definition files, plus the scripts used to control compilation and installation of the executable. However, as a special exception, the source code distributed need not include anything that is normally distributed (in the source code) with the major components (compiler, kernel, and so on) of the operating system on which the executable runs, unless that component itself accompanies the executable.

If distribution of executable or object code is made by offering access to copy from a designated place, then offering equivalent access to copy the source code from the same place counts as distribution of the source code, even though third parties are not compelled to copy the source along with the object code.

You may not copy, modify, sublicense, or distribute the Program except as expressly provided under this License. Any attempt otherwise to copy, modify, sublicense or distribute the Program is void, and will automatically terminate your rights under this License. However, parties who have received copies, or rights, from you under this License will not have their licenses terminated so long as such parties remain in full compliance.

You are not required to accept this License, since you have not signed it. However, nothing else grants you permission to modify or distribute the Program or its derivative works. These actions are prohibited by law if you do not accept this License. Therefore, by modifying or distributing the Program (or any work based on the Program), you indicate your acceptance of this License to do so, and all its terms and conditions for copying, distributing or modifying the Program or works based on it. Each time you redistribute the Program (or any work based on the Program), the recipient automatically receives a license from the original licensor to copy, distribute or modify the Program subject to these terms and conditions. You may not impose any further restrictions on the recipients' exercise of the rights granted herein. You are not responsible for enforcing compliance by third parties to this License.

If, as a consequence of a court judgment or allegation of patent infringement or for any other reason (not limited to patent issues), conditions are imposed on you by patent law or by patent offices that conflict with the conditions of this License, they do not excuse you from the conditions of this License. If you cannot distribute so as to satisfy simultaneously your obligations under this License and any other pertinent obligations, then as a consequence you may not distribute the Program at all. For example, if a patent license would permit royalty-free redistribution of the Program by all those who receive copies directly or indirectly through you, then the only way you could satisfy both it and this License would be to refrain entirely from distribution of the Program.

If any portion of this section is held invalid or unenforceable under any particular circumstance, the balance of the section is intended to apply and the section as a whole is intended to apply in other circumstances.

It is not the purpose of this section to induce you to infringe any patents or other property rights claims or to contest validity of any such claims; this section has the sole purpose of protecting the integrity of the free software distribution system, which is implemented by public license practices. Many people have made generous contributions to the wide range of software distributed through that system in reliance on consistent application of that system; it is up to the author/donor to decide if he or she is willing to distribute software through any other system and a licensee cannot impose that choice.

This section is intended to make thoroughly clear what is believed to be a consequence of the rest of this License. If the distribution and/or use of the Program is restricted in certain countries either by patents or by copyrighted interfaces, the original copyright holder who places the Program under this License may add an explicit geographical distribution limitation excluding those countries, so that distribution is permitted only in or among countries not thus excluded. In such case, this License incorporates the limitation as if written in the body of this License.

NO WARRANTY

**BECAUSE THE PROGRAM IS LICENSED FREE OF CHARGE, THERE IS NO WARRANTY FOR THE PROGRAM, TO THE EXTENT PERMITTED BY APPLICABLE LAW. EXCEPT WHEN OTHERWISE STATED IN WRITING THE COPYRIGHT HOLDERS AND/OR OTHER PARTIES PROVIDE THE PROGRAM "AS IS" WITHOUT WARRANTY OF ANY KIND, EITHER EXPRESSED OR IMPLIED, INCLUDING, BUT NOT LIMITED TO, THE IMPLIED WARRANTIES OF MERCHANTABILITY AND FITNESS FOR A PARTICULAR PURPOSE. THE ENTIRE RISK AS TO THE QUALITY AND PERFORMANCE OF THE PROGRAM IS WITH YOU. SHOULD THE PROGRAM PROVE DEFECTIVE, YOU ASSUME THE COST OF ALL NECESSARY SERVICING, REPAIR OR CORRECTION.**  
**IN NO EVENT UNLESS REQUIRED BY APPLICABLE LAW OR AGREED TO IN WRITING WILL ANY COPYRIGHT HOLDER, OR ANY OTHER PARTY WHO MAY MODIFY AND/OR REDISTRIBUTE THE PROGRAM AS PERMITTED ABOVE, BE LIABLE TO YOU FOR DAMAGES, INCLUDING ANY GENERAL, SPECIAL, INCIDENTAL OR CONSEQUENTIAL DAMAGES ARISING OUT OF THE USE OR INABILITY TO USE THE PROGRAM (INCLUDING BUT NOT LIMITED TO LOSS OF DATA OR DATA BEING RENDERED INACCURATE OR LOSSES SUSTAINED BY YOU OR THIRD PARTIES OR A FAILURE OF THE PROGRAM TO OPERATE WITH ANY OTHER PROGRAMS), EVEN IF SUCH HOLDER OR OTHER PARTY HAS BEEN ADVISED OF THE POSSIBILITY OF SUCH DAMAGES.**

**END OF TERMS AND CONDITIONS**

**How to Apply These Terms to Your New Programs**

If you develop a new program, and you want it to be of the greatest possible use to the public, the best way to achieve this is to make it free software which everyone can redistribute and change under these terms.

To do so, attach the following notices to the program. It is safest to attach them to the start of each source file to most effectively

convey the exclusion of warranty; and each file should have at least the "copyright" line and a pointer to where the full notice is found.

<one line to give the program's name and an idea of what it does >

Copyright (C) <year> <name of author>

This program is free software; you can redistribute it and/or modify it under the terms of the GNU General Public License as published by the Free Software Foundation; either version 2 of the License, or (at your option) any later version.

This program is distributed in the hope that it will be useful, but WITHOUT ANY WARRANTY; without even the implied warranty of MERCHANTABILITY or FITNESS FOR A PARTICULAR PURPOSE. See the GNU General Public License for more details.

You should have received a copy of the GNU General Public License along with this program; if not, write to the Free Software Foundation, Inc., 59 Temple Place - Suite 330, Boston, MA 02111-1307, USA.

Also add information on how to contact you by electronic and paper mail.

If the program is interactive, make it output a short notice like this when it starts in an interactive mode:

Gnomovision version 69, Copyright (C) year the name of author. Gnomovision comes with ABSOLUTELY NO WARRANTY; for details type `show w'. This is free software, and you are welcome to redistribute it under certain conditions; type `show c' for details. The hypothetical commands `show w' and `show c' should show the appropriate parts of the General Public License. Of course, the commands you use may be called something other than `show w' and `show c'; they could even be mouse-clicks or menu items—whatever suits your program.

You should also get your employer (if you work as a programmer) or your school, if any, to sign a "copyright disclaimer" for the program, if necessary. Here is a sample, alter the names:

Yoodyne, Inc., hereby disclaims all copyright interest in the program "Gnomovision" (which makes passes at compilers) written by James Hacker.

<signature of Ty Coon>, 1 April 1989

Ty Coon, President of Vice

This General Public License does not permit incorporating your program into proprietary programs. If you want your program to be subroutines library, you may consider it more useful to permit linking proprietary applications with the library. If this is what you do, write the GNU Library General Public License instead of this License.

**Notice Regarding Third-party Software**

This product includes the following software that is directly or indirectly licensed to Onkyo by third-party developers.

1. bfish-sk
2. ixm1
3. libcurl1
4. libFLAC
5. libjpeg
6. libogg
7. libpng
8. libvorbit
9. libvorbis
10. OpenSSL
11. pptt
12. RSA Data Security, Inc. MD5 Message-Digest Algorithm
13. thp2d 2.5b
14. zlib
15. Apple Lossless
16. Boost
17. Expat
18. FastDelegate
19. Tremolo
20. Tremor
21. Merseenne Twister
22. cURL
23. c-ares
24. LZ4

In response to requests from the copyright owners of each piece of software, Onkyo notifies you of the following important Notice Regarding Other Third-Party Software

This product includes the following software licensed to Onkyo Corporation directly or indirectly by third party developers:

1. bfish-sk
2. ixm1
3. libcurl1
4. libFLAC
5. libjpeg
6. libogg
7. libpng
8. libvorbis
9. rtp
10. OpenSSL
11. pptt
12. RSA Data Security, Inc. MD5 Message-Digest Algorithm
13. thp2d 2.5b
14. zlib
15. Apple Lossless
16. Boost
17. Expat
18. FastDelegate
19. Tremolo
20. Tremor
21. Merseenne Twister
22. cURL
23. c-ares
24. LZ4

In response to requests from the copyright owners of each piece of software, Onkyo notifies you of the following:

(1) bfish-sk

Copyright (c) 2007 Samuel KABAK  
 Permission is hereby granted, free of charge, to any person obtaining a copy of this software and associated documentation files (the "Software"), to deal in the Software without restriction, including without limitation the rights to use, copy, modify, merge, publish, distribute, sublicense, and/or sell copies of the Software, and to permit persons to whom the Software is furnished to do so, subject to the following conditions:

The above copyright notice and this permission notice shall be included in all copies or substantial portions of the Software.

THE SOFTWARE IS PROVIDED "AS IS" WITHOUT WARRANTY OF ANY KIND, EXPRESS OR IMPLIED, INCLUDING



```

mailto: jhay@icomtek.com.co.ca
mailto: glenn@herald.usask.ca
mailto: iglesias@uci.edu
mailto: jagubox.gisf.nasa.gov
mailto: jbj@chatham.usdesign.com
mailto: Hans.Lamberton@ni.origin-it.com
mailto: H.Lamberton@chilo.ni
mailto: ph@FreeBSD.ORG
http://www4.informatik.uni-erlangen.de/nes7ekardel
mailto: kardel(at)nlp(dot)org
mailto: jones@hermes.chpc.utexas.edu
mailto: dkatz@cisico.com
mailto: lenes@en.itl.gov
mailto: lindholm@ucs.ubc.ca
mailto: louie@ni.umd.edu
mailto: thorinn@dku.dk
mailto: mayer@ntp.org
mailto: mila@udel.edu
mailto: moeller@gwdg1_dnet.gwdg.de
mailto: mogul@na.dec.com
mailto: Moore@level.daytonmhr.com
mailto: kamal@whence.com
mailto: derek@toybox.demon.co.uk
mailto: d@hd.org
mailto: Rainier.Fray@informatik.uni-erlangen.de
mailto: dirce@at3.dec.com
mailto: wsanchez@apple.com
mailto: mrrapple@quack.ku.com
mailto: jack@innovativeinternet.com
mailto: schmitz@unipress.com
mailto: shields@temat.org
mailto: pebbles.jtl.nasa.gov
mailto: harlan@pfcs.com
mailto: ken@sdd.hp.com
mailto: aji@ee.udel.edu
mailto: tsuruoka@nc.fukuoaka-u.ac.jp
mailto: vie@ix.com
mailto: Ulrich.Windt@rz.uni-regensburg.de
(10) OpenSSL
LICENSE ISSUES
=====

```

The OpenSSL toolkit stays under a dual license, i.e. both the conditions of the OpenSSL License and the original SSLeay license apply to the toolkit. See below for the actual license texts. Actually both licenses are BSD-style Open Source licenses. In case of any license issues related to OpenSSL, please contact openssl-core@openssl.org.  
OpenSSL License

=====  
Copyright (c) 1998-2007 The OpenSSL Project. All rights reserved.  
Redistribution and use in source and binary forms, with or without modification, are permitted provided that the following conditions are met:  
Redistributions of source code must retain the above copyright notice, this list of conditions and the following disclaimer.  
Redistributions in binary form must reproduce the above copyright notice, this list of conditions and the following disclaimer in the documentation and/or other materials provided with the distribution.  
All advertising materials mentioning features or use of this software must display the following acknowledgment:  
This product includes software developed by the OpenSSL Project for use in the OpenSSL Toolkit. (http://www.openssl.org/)  
The names "OpenSSL Toolkit" and "OpenSSL Project" must not be used to endorse or promote products derived from this software without prior written permission. For written permission, please contact openssl-core@openssl.org.  
Products derived from this software may not be called "OpenSSL" nor may "OpenSSL" appear in their names without prior written permission of the OpenSSL Project.  
This product includes software developed by the OpenSSL Project for use in the OpenSSL Toolkit (http://www.openssl.org/)

=====  
THIS SOFTWARE IS PROVIDED BY THE OPENSSL PROJECT 'AS IS' AND ANY EXPRESSED OR IMPLIED WARRANTIES, INCLUDING, BUT NOT LIMITED TO, THE IMPLIED WARRANTIES OF MERCHANTABILITY AND FITNESS FOR A PARTICULAR PURPOSE ARE DISCLAIMED. IN NO EVENT SHALL THE OPENSSL PROJECT OR ITS CONTRIBUTORS BE LIABLE FOR ANY DIRECT, INDIRECT, INCIDENTAL, SPECIAL, EXEMPLARY, OR CONSEQUENTIAL DAMAGES (INCLUDING, BUT NOT LIMITED TO, PROCUREMENT OF SUBSTITUTE GOODS OR SERVICES; LOSS OF USE, DATA, OR PROFITS; OR BUSINESS INTERRUPTION) HOWEVER CAUSED AND ON ANY THEORY OF LIABILITY, WHETHER IN CONTRACT, STRICT LIABILITY, OR TORT (INCLUDING NEGLIGENCE OR OTHERWISE) ARISING IN ANY WAY OUT OF THE USE OF THIS SOFTWARE, EVEN IF ADVISED OF THE POSSIBILITY OF SUCH DAMAGE.  
=====  
THIS product includes cryptographic software written by Eric Young (eay@cryptsoft.com). This product includes software written by Tim Hudson (tjh@cryptsoft.com).  
Original SSLeay License

=====  
Copyright (C) 1995-1998 Eric Young (eay@cryptsoft.com) All rights reserved.  
This package is a SSL implementation written by Eric Young (eay@cryptsoft.com).  
The implementation was written so as to conform with Netscape's SSL.  
This library is free for commercial and non-commercial use as long as the following conditions are adhered to. The following conditions apply to all code found in this distribution, be it the RC4, RSA, lhash, DES, etc., code; not just the SSL code. The SSL documentation included with this distribution is covered by the same copyright terms except that the holder is Tim Hudson (tjh@cryptsoft.com).

=====  
Copyright remains Eric Young's, and as such any copyright notices in the code are not to be removed.  
If you find any bugs in the product, Eric Young should be given attribution as the author of the parts of the library used. This can be in the form of a textual message at program startup or in documentation (online or textual) provided with the package. Redistribution and use in source and binary forms, with or without modification, are permitted provided that the following conditions are met:  
Redistributions of source code must retain the copyright notice, this list of conditions and the following disclaimer.

Redistributions in binary form must reproduce the above copyright notice, this list of conditions and the following disclaimer in the documentation and/or other materials provided with the distribution.

All advertising materials mentioning features or use of this software must display the following acknowledgement: "Eric Young (eay@cryptsoft.com)"  
The word "cryptographic" can be left out if the routines from the library being used are not cryptographic related :-).

If you include any Windows specific code (or a derivative thereof) from the apps directory (application code) you must include an acknowledgement: "This product includes software written by Tim Hudson (tjh@cryptsoft.com)"  
**THIS SOFTWARE IS PROVIDED BY ERIC YOUNG 'AS IS' AND ANY EXPRESS OR IMPLIED WARRANTIES, INCLUDING, BUT NOT LIMITED TO, THE IMPLIED WARRANTIES OF MERCHANTABILITY AND FITNESS FOR A PARTICULAR PURPOSE ARE DISCLAIMED. IN NO EVENT SHALL THE AUTHOR OR CONTRIBUTORS BE LIABLE FOR ANY DIRECT, INDIRECT, INCIDENTAL, SPECIAL, EXEMPLARY, OR CONSEQUENTIAL DAMAGES (INCLUDING, BUT NOT LIMITED TO, PROCUREMENT OF SUBSTITUTE GOODS OR SERVICES; LOSS OF USE, DATA, OR PROFITS; OR BUSINESS INTERRUPTION) HOWEVER CAUSED AND ON ANY THEORY OF LIABILITY, WHETHER IN CONTRACT, STRICT LIABILITY, OR TORT (INCLUDING NEGLIGENCE OR OTHERWISE) ARISING IN ANY WAY OUT OF THE USE OF THIS SOFTWARE, EVEN IF ADVISED OF THE POSSIBILITY OF SUCH DAMAGE.**

=====  
(11) pop3  
Copyright (c) 1998 Red Hat Software  
Permission is hereby granted, free of charge, to any person obtaining a copy of this software and associated documentation files (the "Software"), to deal in the Software without restriction, including without limitation the rights to use, copy, modify, merge, publish, distribute, sublicense, and/or sell copies of the Software, and to permit persons to whom the Software is furnished to do so, subject to the following conditions:  
The above copyright notice and this permission notice shall be included in all copies or substantial portions of the Software.  
**THE SOFTWARE IS PROVIDED 'AS IS', WITHOUT WARRANTY OF ANY KIND, EXPRESS OR IMPLIED, INCLUDING BUT NOT LIMITED TO, THE WARRANTIES OF MERCHANTABILITY, FITNESS FOR A PARTICULAR PURPOSE AND NONINFRINGEMENT. IN NO EVENT SHALL THE X CONSORTIUM BE LIABLE FOR ANY CLAIM, DAMAGES OR OTHER LIABILITY, WHETHER IN AN ACTION OF CONTRACT, TORT OR OTHERWISE, ARISING FROM, OUT OF OR IN CONNECTION WITH THE SOFTWARE OR THE USE OR OTHER DEALINGS IN THE SOFTWARE.**

=====  
Except as contained in this notice, the name of the X Consortium shall not be used in advertising or otherwise to promote the sale, use or other dealings in this Software without prior written authorization from the X Consortium.  
(12) RSA Data Security, Inc. MD5 Message-Digest Algorithm.  
Copyright (C) 1991-2, RSA Data Security, Inc. Created 1991. All rights reserved.  
License to copy and use this software is granted provided that it is identified as the "RSA Data Security, Inc. MD5 Message-Digest Algorithm" in all material mentioning or referencing this software or this function.  
License is also granted to make and use derivative works provided that such works are identified as "derived from the RSA Data Security, Inc. MD5 Message-Digest Algorithm" in all material mentioning or referencing the derived work.  
RSA Data Security, Inc. makes no representations concerning either the merchantability of this software or the suitability of this software for any particular purpose. It is provided "as is" without express or implied warranty of any kind.  
These notices must be retained in any copies of any part of this documentation and/or software.  
(13) httplib 2.25b  
Copyright c 2000 by Jef Poskanzer <jef@mail.acme.com>. All rights reserved.  
Redistribution and use in source and binary forms, with or without modification, are permitted provided that the following conditions are met:  
Redistributions of source code must retain the above copyright notice, this list of conditions and the following disclaimer.  
Redistributions in binary form must reproduce the above copyright notice, this list of conditions and the following disclaimer in the documentation and/or other materials provided with the distribution.  
**THIS SOFTWARE IS PROVIDED BY THE AUTHOR AND CONTRIBUTORS 'AS IS' AND ANY EXPRESS OR IMPLIED WARRANTIES, INCLUDING, BUT NOT LIMITED TO, THE IMPLIED WARRANTIES OF MERCHANTABILITY AND FITNESS FOR A PARTICULAR PURPOSE ARE DISCLAIMED. IN NO EVENT SHALL THE AUTHOR OR CONTRIBUTORS BE LIABLE FOR ANY DIRECT, INDIRECT, INCIDENTAL, SPECIAL, EXEMPLARY, OR CONSEQUENTIAL DAMAGES (INCLUDING, BUT NOT LIMITED TO, PROCUREMENT OF SUBSTITUTE GOODS OR SERVICES; LOSS OF USE, DATA, OR PROFITS; OR BUSINESS INTERRUPTION) HOWEVER CAUSED AND ON ANY THEORY OF LIABILITY, WHETHER IN CONTRACT, STRICT LIABILITY, OR TORT (INCLUDING NEGLIGENCE OR OTHERWISE) ARISING IN ANY WAY OUT OF THE USE OF THIS SOFTWARE, EVEN IF ADVISED OF THE POSSIBILITY OF SUCH DAMAGE.**

=====  
(14) zlib  
zlib.h -- interface of the 'zlib' general purpose compression library version 1.1.4, March 11th, 2002  
Copyright (C) 1995-2002 Jean-loup Gailly and Mark Adler  
This software is provided 'as-is', without any express or implied warranty. In no event will the authors be held liable for any damages arising from the use of this software.  
Permission is granted to anyone to use this software for any purpose, including commercial applications, and to alter it and redistribute it freely, subject to the following restrictions:  
The origin of this software must not be misrepresented; you must not claim that you wrote the original software. If you use this software in a product, an acknowledgment in the product documentation would be appreciated but is not required.  
Altered source versions must be plainly marked as such, and must not be misrepresented as being the original software.  
This notice may not be removed or altered from any source distribution.  
Jean-loup Gailly Mark Adler  
jlg@zip.org m Adler@alumni.caltech.edu

=====  
The data format used by the zlib library is described by RFCs (Request for Comments) 1950 to 1952 in the files ftp://ds.internic.net/rfc/1950.txt (zlib format), rfc1951.txt (deflate format) and rfc1952.txt (gzip format).  
(15) Apache License  
Apache License  
Version 2.0, January 2004  
http://www.apache.org/licenses/

TERMS AND CONDITIONS FOR USE, REPRODUCTION, AND DISTRIBUTION

Definitions.

"License" shall mean the terms and conditions for use, reproduction, and distribution as defined by Sections 1 through 9 of this document.  
"Licensor" shall mean the copyright owner or entity authorized by the copyright owner that is granting the License.  
"Legal Entity" shall mean the union of the acting entity and all other entities that control, are controlled by, or are under common control with that entity. For the purposes of this definition, "control" means (i) the power, direct or indirect, to cause the direction or management of such entity, whether by contract or otherwise, or (ii) ownership of fifty percent (50%) or more of the outstanding shares, or (iii) beneficial ownership of such entity.

"You" (or "Your") shall mean an individual or Legal Entity exercising permissions granted by this License.

"Source" form shall mean the preferred form for making modifications, including but not limited to software source code, documentation source, and configuration files.

"Object" form shall mean any form resulting from mechanical transformation or translation of a Source form, including but not limited to compiled object code, generated documentation, and conversions to other media types.

"Work" shall mean the work of authorship, whether in Source or Object form, made available under this License, as indicated by a copyright notice that is included in or attached to the work (an example is provided in the Appendix below).

"Derivative Works" shall mean any work, whether in Source or Object form, that is based on (or derived from) the Work and for which the editorial revisions, annotations, elaborations, or other modifications represent, as a whole, an original work of authorship. For the purposes of this License, Derivative Works shall not include works that remain separate from, or merely link (or bind by name) to the interfaces of, the Work and Derivative Works thereof.

"Contribution" shall mean any work of authorship, including the original version of the Work and any modifications or additions to that Work of authorship that are intentionally submitted to Licensor for inclusion in the Work by the copyright owner or by an individual or Legal Entity authorized to submit on behalf of the copyright owner. For the purposes of this definition, "submitted" means any form of electronic, verbal, or written communication sent to the Licensor or its representatives, including but not limited to communication on electronic mailing lists, source code control systems, and issue tracking systems that are managed by, or on behalf of, the Licensor for the purpose of discussing and improving the Work, but excluding communication that is conspicuously marked or otherwise designated in writing by the copyright owner as "Not a Contribution."

"Contributor" shall mean Licensor and any individual or Legal Entity on behalf of whom a Contribution has been received by Licensor and subsequently incorporated within the Work.

Grant of Copyright License.

Subject to the terms and conditions of this License, each Contributor hereby grants to You a perpetual, worldwide, non-exclusive, non-charge, royalty-free, irrevocable copyright license to reproduce, prepare Derivative Works of, publicly display, publicly perform, sublicense, and distribute the Work and such Derivative Works in Source or Object form.

Grant of Patent License.

Subject to the terms and conditions of this License, each Contributor hereby grants to You a perpetual, worldwide, non-exclusive, non-charge, royalty-free, irrevocable (except as stated in this section) patent license to make, have made, use, offer to sell, sell, import, and otherwise transfer the Work, where such license applies only to those patent claims licensable by such Contributor that are necessarily infringed by their Contribution(s) alone or by combination of their Contribution(s) with the Work to which such Contribution(s) was submitted. If you institute patent litigation against any entity (including a cross-claim or counterclaim in a lawsuit) alleging that the Work or a Contribution incorporated within the Work constitutes direct or contributory patent infringement, then any patent licenses granted to You under this license that do not survive such litigation shall be deemed to have terminated as of the date such litigation is filed.

Redistribution.

You may reproduce and distribute copies of the Work or Derivative Works thereof in any medium, with or without modifications, and in Source or Object form, provided that You meet the following conditions:

You must give any other recipients of the Work or Derivative Works a copy of this License; and

You must cause any modified files to carry prominent notices stating that You changed the files; and

You must retain, in the Source form of any Derivative Works that You distribute, all copyright, patent, trademark, and attribution notices from the Source form of the Work, excluding those notices that do not pertain to any part of the Derivative Works; and if the Work includes a "NOTICE" text file as part of its distribution, then any Derivative Works that You distribute must include a readable copy of the attribution notices contained within such NOTICE file, excluding those notices that do not pertain to any part of the Derivative Works, in at least one of the following places: within a NOTICE text file distributed as part of the Derivative Works; within the Source form or documentation, if provided along with the Derivative Works; or, within a display generated by the Derivative Works, if and wherever such third-party notices normally appear. The contents of the NOTICE file are for informational purposes only and do not modify the License. You may add Your own attribution notices within Derivative Works that You distribute, alongside or as an addendum to the NOTICE text from the Work, provided that such additional attribution notices cannot be construed as modifying the License.

You may add Your own copyright statement to Your modifications and may provide additional or different license terms and conditions for use, reproduction, or distribution of Your modifications, or for any such Derivative Works as a whole, provided Your use, reproduction, and distribution of the Work otherwise complies with the conditions stated in this License.

Submission of Contributions.

Unless You explicitly state otherwise, any Contribution intentionally submitted for inclusion in the Work by You to the Licensor shall be under the terms and conditions of this License, without any additional terms or conditions. Notwithstanding the above, nothing herein shall supersede or modify the terms of any separate license agreement you may have executed with Licensor regarding such Contributions.

Trademarks.

This License does not grant permission to use the trade names, trademarks, service marks, or product names of the Licensor, except as required for reasonable and customary use in describing the origin of the Work and reproducing the content of the NOTICE file.

Disclaimer of Warranty.

Unless required by applicable law or agreed to in writing, Licensor provides the Work (and each Contributor provides its Contributions) on an "AS IS" BASIS, WITHOUT WARRANTIES OR CONDITIONS OF ANY KIND, either express or implied, including, without limitation, any warranties or conditions of TITLE, NON-INFRINGEMENT, MERCHANTABILITY, or FITNESS FOR A PARTICULAR PURPOSE. You are solely responsible for determining the appropriateness of using or redistributing the Work and assume any risks associated with Your exercise of permissions under this License.

Limitation of Liability.

In no event and under no legal theory, whether in tort (including negligence), contract, or otherwise, unless required by applicable law (such as deliberate and grossly negligent acts) or agreed to in writing, shall any Contributor be liable to You for damages, including any direct, indirect, special, incidental, or consequential damages of any character arising as a result of this License or out of the use or inability to use the Work (including but not limited to damages for loss of goodwill, work stoppage, computer failure or malfunction, or any and all other commercial damages or losses), even if such Contributor has been advised of the possibility of such damages.

Accepting Warranty or Additional Liability.

While redistributing the Work or Derivative Works thereof, You may choose to offer, and charge a fee for, acceptance of support, warranty, indemnity, or other liability obligations and/or rights consistent with this License. However, in accepting such obligations, You may act only on Your own behalf and on Your sole responsibility, not on behalf of any other Contributor, and only if You agree to indemnify, defend, and hold each Contributor harmless for any liability incurred by, or claims asserted against, such Contributor by reason of your accepting any such warranty or additional liability.

END OF TERMS AND CONDITIONS

APPENDIX: How to apply the Apache License to your work.

To apply the Apache License to your work, attach the following boilerplate notice, with the fields enclosed by brackets [ ] replaced with your own identifying information. (Don't include the brackets!) The text should be enclosed in the appropriate comment syntax for the file format. We also recommend that a file or class name and description of purpose be included on the same "printed page" as the copyright notice for easier identification within third-party archives.

Copyright © 2011 Apple Inc. All rights reserved.

Licensed under the Apache License, Version 2.0 (the "License"); you may not use this file except in compliance with the License. You may obtain a copy of the License at

<http://www.apache.org/licenses/LICENSE-2.0>

Unless required by applicable law or agreed to in writing, software distributed under the License is distributed on an "AS IS" BASIS, WITHOUT WARRANTIES OR CONDITIONS OF ANY KIND, either express or implied.

See the License for the specific language governing permissions and limitations under the license.

(16) Boost
<http://www.boost.org/>
Boost Software License - Version 1.0 - August 17th, 2003
Permission is hereby granted, free of charge, to any person or organization obtaining a copy of the software and accompanying documentation covered by this license (the "Software") to use, reproduce, display, distribute, execute, and transmit the Software, and to prepare derivative works of the Software, and to permit third-parties to whom the Software is furnished to do so, all subject to the following:

The copyright notices in the Software and this entire statement, including the above license grant, this restriction and the following disclaimer, must be included in all copies of the Software, in whole or in part, and in all derivative works of the Software, unless such copies or derivative works are solely in the form of machine-executable object code generated by a source language processor.

THE SOFTWARE IS PROVIDED "AS IS", WITHOUT WARRANTY OF ANY KIND, EXPRESS OR IMPLIED, INCLUDING BUT NOT LIMITED TO THE WARRANTIES OF MERCHANTABILITY, FITNESS FOR A PARTICULAR PURPOSE, TITLE AND NON-INFRINGEMENT, IN NO EVENT SHALL THE COPYRIGHT HOLDERS OR ANYONE DISTRIBUTING THE SOFTWARE BE LIABLE FOR ANY DAMAGES OR OTHER LIABILITY, WHETHER IN CONTRACT, TORT OR OTHERWISE, ARISING FROM, OUT OF OR IN CONNECTION WITH THE SOFTWARE OR THE USE OR OTHER DEALINGS IN THE SOFTWARE.

(17) Expat
<http://www.icatk.com/xml/expat.html>
Expat License. Copyright (c) 1998, 1999, 2000 That Open Source Software Center Ltd
Permission is hereby granted, free of charge, to any person obtaining a copy of this software and associated documentation files (the "Software"), to deal in the Software without restriction, including without limitation the rights to use, copy, modify, merge, publish, distribute, sublicense, and/or sell copies of the Software, and to permit persons to whom the Software is furnished to do so, subject to the following conditions:

The copyright notice and this permission notice shall be included in all copies or substantial portions of the Software. THE SOFTWARE IS PROVIDED "AS IS", WITHOUT WARRANTY OF ANY KIND, EXPRESS OR IMPLIED, INCLUDING BUT NOT LIMITED TO THE WARRANTIES OF MERCHANTABILITY, FITNESS FOR A PARTICULAR PURPOSE AND NONINFRINGEMENT. IN NO EVENT SHALL THE AUTHORS OR COPYRIGHT HOLDERS BE LIABLE FOR ANY CLAIM, DAMAGES OR OTHER LIABILITY, WHETHER IN AN ACTION OF CONTRACT, TORT OR OTHERWISE, ARISING FROM, OUT OF OR IN CONNECTION WITH THE SOFTWARE OR THE USE OR OTHER DEALINGS IN THE SOFTWARE.

(18) FastDelegate
<http://www.codeproject.com/KB/cpp/FastDelegate.aspx>
THE WORK (AS DEFINED BELOW) IS PROVIDED UNDER THE TERMS OF THIS CODE PROJECT OPEN LICENSE ("LICENSE"). THE WORK IS PROTECTED BY COPYRIGHT AND/OR OTHER APPLICABLE LAW. ANY USE OF THE WORK OTHER THAN AS AUTHORIZED UNDER THIS LICENSE OR COPYRIGHT LAW IS PROHIBITED.

BY EXERCISING ANY RIGHTS TO THE WORK PROVIDED HEREIN, YOU ACCEPT AND AGREE TO BE BOUND BY THE TERMS OF THIS LICENSE. THE AUTHOR GRANTS YOU THE RIGHTS CONTAINED HEREIN IN CONSIDERATION OF YOUR ACCEPTANCE OF SUCH TERMS AND CONDITIONS. IF YOU DO NOT AGREE TO ACCEPT AND BE BOUND BY THE TERMS OF THIS LICENSE, YOU CANNOT MAKE ANY USE OF THE WORK.

- Definitions.
a. "Articles" means, collectively, all articles written by Author which describes how the Source Code and Executable Files for the Work may be used by a user.
b. "Author" means the individual or entity that offers the Work under the terms of this License.
c. "Derivative Work" means a work based upon the Work or upon the Work and other pre-existing works.
d. "Executable Files" refer to the executed binaries, binary files, configuration and any required data files included in the Work.
e. "Publisher" means the provider of the website, magazine, CD-ROM, DVD or other medium from or by which the Work is obtained by You.
f. "Source Code" refers to the collection of source code and configuration files used to create the Executable Files.
g. "Standard Version" refers to such a Work if it has not been modified, or has been modified in accordance with the consent of the Author, such consent being in the full discretion of the Author.
h. "Work" refers to the collection of files distributed by the Publisher, including the Source Code, Executable Files, binaries, data files, documentation, whitepapers and the Articles.

i. "You" is you, an individual or entity wishing to use the Work and exercise your rights under this License. Fair Use/Fair Uses. Nothing in this License is intended to reduce, limit, or restrict any rights arising from fair use, fair dealing, first sale or other limitations on the exclusive rights of the copyright owner under copyright law or other applicable laws. License Grant. Subject to the terms and conditions of this License, the Author hereby grants You a worldwide, royalty-free, non-exclusive, perpetual (for the duration of the applicable copyright) license to exercise the rights in the Work as stated below:

- a. You may use the standard version of the Source Code or Executable Files in Your own applications.
b. You may copy, republish, retransmit, distribute, sell, modify, sublicense, or create derivative works of the Work under this License for any form or for any medium, whether physical or electronic, and for any purpose, without fee or charge, and without liability to anyone for redistribution, provided that all copyright notices, patent notices, trade dress notices, known to the Author, A Work modified in such a way shall still be considered the standard version and will be subject to this License.
c. You may otherwise modify Your copy of this Work (excluding the Articles) in any way to create a Derivative Work, provided that You insert a prominent notice in each changed file stating how, when and where You changed that file.
d. You may distribute the standard version of the Executable Files and Source Code or Derivative Work in aggregate with other (possibly commercial) programs as part of a larger (possibly commercial) software distribution.

The Articles disclosing the Work published in any form by the author may not be distributed or reproduced without the Author's consent. The Author retains copyright in any such Articles. You may use the Executable Files and Source Code pursuant to this License but you may not repost or republish or otherwise distribute or make available the Articles, without the prior written consent of the Author.

Any subroutines or modules supplied by You and linked into the Source Code or Executable Files this Work shall not be considered part of this Work and will not be subject to the terms of this License.

Patent License. Subject to the terms and conditions of this License, each Author hereby grants to You a perpetual, worldwide, non-exclusive, no-charge, royalty-free, irrevocable (except as stated in this section) patent license to make, have made, use, import, and otherwise transfer the Work.

- Restrictions. The license granted in Section 3 above is expressly made subject to and limited by the following restrictions:
a. You agree not to remove any of the original copyright, patent, trademark, and attribution notices and associated disclaimers that may appear in the Source Code or Executable Files.
b. You may not advertise or in any way imply that this Work is a product of Your own.
c. The name of the Author may not be used to endorse or promote products derived from the Work without the prior written consent of the Author.

d. You agree not to sell, lease, or rent any part of the Work. This does not restrict you from including the Work or any part of the Work inside a larger software distribution that itself is being sold. The Work by itself, though, cannot be sold, leased or rented.

e. You may distribute the Executable Files and Source Code only under the terms of this License, and You must include a copy of, or the Uniform Resource Identifier for, this License with every copy of the Executable Files or Source Code You distribute and ensure that anyone receiving such Executable Files and Source Code agrees that the terms of this License apply to such Executable Files and/or Source Code. You may not offer or impose any terms on the Work that alter or restrict the terms of this License or the recipients' exercise of the rights granted hereunder. You may not sublicense the Work. You must keep intact all notices that refer to this License and to the disclaimer of warranties. You may not distribute the Executable Files or Source Code with any technological measures that control access or use of the Work in a manner inconsistent with the terms of this License.

f. You agree not to use the Work for illegal, immoral or improper purposes, or on pages containing illegal, immoral or improper material. The Work is subject to applicable export laws. You agree to comply with all such laws and regulations that may apply to the Work after Your receipt of the Work.

Representations, Warranties and Disclaimer: THIS WORK IS PROVIDED "AS IS", "WHERE IS" AND "AS AVAILABLE" WITHOUT ANY EXPRESS OR IMPLIED WARRANTIES OR CONDITIONS OF ANY KIND, AND WITHOUT ANY EXPRESS OR IMPLIED ALL RISK IN ITS USE, INCLUDING COPYRIGHT INFRINGEMENT, PATENT INFRINGEMENT, SUITABILITY, ETC. AUTHOR EXPRESSLY DISCLAIMS ALL EXPRESS, IMPLIED OR STATUTORY WARRANTIES OR CONDITIONS, INCLUDING WITHOUT LIMITATION, WARRANTIES OR CONDITIONS OF MERCHANTABILITY, MERCHANTABILITY QUALITY OR FITNESS FOR A PARTICULAR PURPOSE, OR ANY WARRANTY OF TITLE OR NON-INFRINGEMENT, OR THAT THE WORK (OR ANY PORTION THEREOF) IS CORRECT, USEFUL, BUG-FREE OR FREE OF VIRUSES; YOU MUST PASS THIS DISCLAIMER ON TO ANY PERSON TO WHOM YOU DISTRIBUTE THE WORK OR DERIVATIVE WORKS. Indemnity. You agree to defend, indemnify and hold harmless the Author and the Publisher from and against any claims, suits, losses, damages, liabilities, costs, and expenses (including reasonable legal or attorneys' fees) resulting from or relating to any use of the Work by You.

Limitation on Liability. EXCEPT TO THE EXTENT REQUIRED BY APPLICABLE LAW, IN NO EVENT WILL THE AUTHOR OR THE PUBLISHER BE LIABLE TO YOU ON ANY LEGAL THEORY FOR ANY SPECIAL, INCIDENTAL, CONSEQUENTIAL, PUNITIVE OR EXEMPLARY DAMAGES ARISING OUT OF THIS LICENSE OR THE USE OF THE WORK OR OTHERWISE, EVEN IF THE AUTHOR OR THE PUBLISHER HAS BEEN ADVISED OF THE POSSIBILITY OF SUCH DAMAGES.

Termination.
This License and the rights granted hereunder will terminate automatically upon any breach by You of any term of this License. Individuals or entities who have received Derivative Works from You under this License, however, will not have their licenses terminated provided such individuals or entities remain in full compliance with those licenses. Sections 1, 2, 6, 7, 8, 9, 10 and 11 will be applied to any individual or entity to whom this license should apply.

a. If you bring a copyright, trademark, patent or any other infringement claim against any contributor over infringements you claim are made by the Work, your License from such contributor to the Work ends automatically.
c. Subject to the above terms and conditions, this License is perpetual (for the duration of the applicable copyright in the Work). Notwithstanding the above, the Author reserves the right to release the Work under different license terms or to stop distributing the Work at any time, provided, however that any such election will not serve to withdraw this License (or any other license that has been granted) from the Work (or any part of the Work) and this License will continue in full force and effect unless terminated as stated above.

Publisher. The parties hereby confirm that the Publisher shall not, under any circumstances, be responsible for and shall not have any liability in respect of the subject matter of this License. The Publisher makes no warranty whatsoever in connection with the Work and shall not be liable to You or any party on any legal theory for any damages whatsoever, including without limitation any general, special, incidental or consequential damages arising in connection to this license. The Publisher reserves the right to cease making the Work available to You at any time without notice.

Miscellaneous
(19) Tremolo
<http://wes.co.uk/pinknoise/tremolo>
Copyright (C) 2002-2009 Xiph.org Foundation Changes Copyright (C) 2009-2010 Robin Watts for Pinknoise Productions Ltd

Redistribution and use in source and binary forms, with or without modification, are permitted provided that the following conditions are met:

- a. Redistributions of source code must retain the above copyright notice, this list of conditions and the following disclaimer.
b. Redistributions in binary form must reproduce the above copyright notice, this list of conditions and the following disclaimer in the documentation and/or other materials provided with the distribution.
c. Neither the name of the Author nor the names of its contributors may be used to endorse or promote products derived from this software without specific prior written permission.
d. THIS SOFTWARE IS PROVIDED BY THE COPYRIGHT HOLDERS AND CONTRIBUTORS "AS IS" AND ANY EXPRESS OR IMPLIED WARRANTIES, INCLUDING, BUT NOT LIMITED TO, THE IMPLIED WARRANTIES OF MERCHANTABILITY AND FITNESS FOR A PARTICULAR PURPOSE ARE DISCLAIMED. IN NO EVENT SHALL THE FOUNDATION OR CONTRIBUTORS BE LIABLE FOR ANY DIRECT, INDIRECT, INCIDENTAL, SPECIAL, EXEMPLARY, OR CONSEQUENTIAL DAMAGES (INCLUDING, BUT NOT LIMITED TO, PROCUREMENT OF SUBSTITUTE GOODS OR SERVICES; LOSS OF USE, DATA, OR PROFITS; OR BUSINESS INTERRUPTION) HOWEVER CAUSED AND ON ANY THEORY OF LIABILITY, WHETHER IN CONTRACT, STRICT LIABILITY, OR TORT (INCLUDING NEGLIGENCE OR OTHERWISE) ARISING IN ANY WAY OUT OF THE USE OF THIS SOFTWARE, EVEN IF ADVISED OF THE POSSIBILITY OF SUCH DAMAGE.
(20) Tremor
<http://wiki.xiph.org/index.php/Tremor>
Copyright (c) 2002, Xiph.org Foundation
Redistribution and use in source and binary forms, with or without modification, are permitted provided that the following conditions are met:

Redistributions of source code must retain the above copyright notice, this list of conditions and the following disclaimer:
Redistributions in binary form must reproduce the above copyright notice, this list of conditions and the following disclaimer in the documentation and/or other materials provided with the distribution.

Neither the name of the Xiph.org Foundation nor the names of its contributors may be used to endorse or promote products derived from this software without specific prior written permission.

THIS SOFTWARE IS PROVIDED BY THE COPYRIGHT HOLDERS AND CONTRIBUTORS "AS IS" AND ANY EXPRESS OR IMPLIED WARRANTIES, INCLUDING, BUT NOT LIMITED TO, THE IMPLIED WARRANTIES OF MERCHANTABILITY AND FITNESS FOR A PARTICULAR PURPOSE ARE DISCLAIMED. IN NO EVENT SHALL THE FOUNDATION OR CONTRIBUTORS BE LIABLE FOR ANY DIRECT, INDIRECT, INCIDENTAL, SPECIAL, EXEMPLARY, OR CONSEQUENTIAL DAMAGES (INCLUDING, BUT NOT LIMITED TO, PROCUREMENT OF SUBSTITUTE GOODS OR SERVICES; LOSS OF USE, DATA, OR PROFITS; OR BUSINESS INTERRUPTION) HOWEVER CAUSED AND ON ANY THEORY OF LIABILITY, WHETHER IN CONTRACT, STRICT LIABILITY, OR TORT (INCLUDING NEGLIGENCE OR OTHERWISE) ARISING IN ANY WAY OUT OF THE USE OF THIS SOFTWARE, EVEN IF ADVISED OF THE POSSIBILITY OF SUCH DAMAGE.

(21) Merseenne Twister
<http://www.math.sci.hiroshima-u.ac.jp/m-mat/MTM2002/ODES/mt19937.c>
Copyright (C) 1997 - 2002, Makoto Matsumoto and Takju Niishimura.
All rights reserved.

Redistribution and use in source and binary forms, with or without modification, are permitted provided that the following conditions are met:

- Redistributions of source code must retain the above copyright notice, this list of conditions and the following disclaimer.
b. Redistributions in binary form must reproduce the above copyright notice, this list of conditions and the following disclaimer in the documentation and/or other materials provided with the distribution.

Neither the name of the Xiph.org Foundation nor the names of its contributors may be used to endorse or promote products derived from this software without specific prior written permission.
THIS SOFTWARE IS PROVIDED BY THE COPYRIGHT HOLDERS AND CONTRIBUTORS "AS IS" AND ANY EXPRESS OR IMPLIED WARRANTIES, INCLUDING, BUT NOT LIMITED TO, THE IMPLIED WARRANTIES OF MERCHANTABILITY AND FITNESS FOR A PARTICULAR PURPOSE ARE DISCLAIMED. IN NO EVENT SHALL THE FOUNDATION OR CONTRIBUTORS BE LIABLE FOR ANY DIRECT, INDIRECT, INCIDENTAL, SPECIAL, EXEMPLARY, OR CONSEQUENTIAL DAMAGES (INCLUDING, BUT NOT LIMITED TO, PROCUREMENT OF SUBSTITUTE GOODS OR SERVICES; LOSS OF USE, DATA, OR PROFITS; OR BUSINESS INTERRUPTION) HOWEVER CAUSED AND ON ANY THEORY OF LIABILITY, WHETHER IN CONTRACT, STRICT LIABILITY, OR TORT (INCLUDING NEGLIGENCE OR OTHERWISE) ARISING IN ANY WAY OUT OF THE USE OF THIS SOFTWARE, EVEN IF ADVISED OF THE POSSIBILITY OF SUCH DAMAGE.

(22) curl
<http://curl.haxx.se>
COPYRIGHT AND PERMISSION NOTICE
Copyright (c) 1996 - 2011, Daniel Stenberg, <daniel@haxx.se>. All rights reserved.

Redistribution and use in source and binary forms, with or without modification, are permitted provided that the following conditions are met:
Redistributions of source code must retain the above copyright notice, this list of conditions and the following disclaimer.
Redistributions in binary form must reproduce the above copyright notice, this list of conditions and the following disclaimer in the documentation and/or other materials provided with the distribution.

Neither the name of the contributors may not be used to endorse or promote products derived from this software without specific prior written permission.

THIS SOFTWARE IS PROVIDED BY THE COPYRIGHT HOLDERS AND CONTRIBUTORS "AS IS" AND ANY EXPRESS OR IMPLIED WARRANTIES, INCLUDING, BUT NOT LIMITED TO, THE IMPLIED WARRANTIES OF MERCHANTABILITY AND FITNESS FOR A PARTICULAR PURPOSE ARE DISCLAIMED. IN NO EVENT SHALL THE FOUNDATION OR CONTRIBUTORS BE LIABLE FOR ANY DIRECT, INDIRECT, INCIDENTAL, SPECIAL, EXEMPLARY, OR CONSEQUENTIAL DAMAGES (INCLUDING, BUT NOT LIMITED TO, PROCUREMENT OF SUBSTITUTE GOODS OR SERVICES; LOSS OF USE, DATA, OR PROFITS; OR BUSINESS INTERRUPTION) HOWEVER CAUSED AND ON ANY THEORY OF LIABILITY, WHETHER IN CONTRACT, STRICT LIABILITY, OR TORT (INCLUDING NEGLIGENCE OR OTHERWISE) ARISING IN ANY WAY OUT OF THE USE OF THIS SOFTWARE, EVEN IF ADVISED OF THE POSSIBILITY OF SUCH DAMAGE.

(23) cURL
<http://curl.haxx.se>
COPYRIGHT AND PERMISSION NOTICE
Copyright (c) 1996 - 2011, Daniel Stenberg, <daniel@haxx.se>. All rights reserved.

Permission to use, copy, modify, and distribute the software for any purpose with or without fee is hereby granted, provided that the above copyright notice and this permission notice appear in all copies.
THE SOFTWARE IS PROVIDED "AS IS", WITHOUT WARRANTY OF ANY KIND, EXPRESS OR IMPLIED, INCLUDING BUT NOT LIMITED TO THE WARRANTIES OF MERCHANTABILITY, FITNESS FOR A PARTICULAR PURPOSE AND NONINFRINGEMENT. IN NO EVENT SHALL THE AUTHORS OR COPYRIGHT HOLDERS BE LIABLE FOR ANY CLAIM, DAMAGES OR OTHER LIABILITY, WHETHER IN AN ACTION OF CONTRACT, TORT OR OTHERWISE, ARISING FROM, OUT OF OR IN CONNECTION WITH THE SOFTWARE OR THE USE OR OTHER DEALINGS IN THE SOFTWARE.

Except as contained in this notice, the name of a copyright holder shall not be used in advertising or otherwise to promote the sale, use, or other dealings in this Software without prior written authorization of the copyright holder.

(24) ares.haxx.se
Copyright 1998 by the Massachusetts Institute of Technology.

Permission to use, copy, modify, and distribute the software and its documentation for any purpose and without fee is hereby granted, provided that the above copyright notice appear in all copies and that both that copyright notice and this permission notice appear in supporting documentation, and that the name of M.I.T. not be used in advertising or publicity pertaining to distribution of the software without specific, written prior permission. M.I.T. makes no representations about the suitability of this software for any purpose. It is provided "as is" without express or implied warranty.

(24)Z4
Copyright (c) 2011-2014, Yann Collet All rights reserved.
Redistribution and use in source and binary forms, with or without modification, are permitted provided that the following conditions are met:

- \* Redistributions of source code must retain the above copyright notice, this list of conditions and the following disclaimer.
\* Redistributions in binary form must reproduce the above copyright notice, this list of conditions and the following disclaimer in the documentation and/or other materials provided with the distribution.
THIS SOFTWARE IS PROVIDED BY THE COPYRIGHT HOLDERS AND CONTRIBUTORS "AS IS" AND ANY EXPRESS OR IMPLIED WARRANTIES, INCLUDING, BUT NOT LIMITED TO, THE IMPLIED WARRANTIES OF MERCHANTABILITY AND FITNESS FOR A PARTICULAR PURPOSE ARE DISCLAIMED. IN NO EVENT SHALL THE FOUNDATION OR CONTRIBUTORS BE LIABLE FOR ANY DIRECT, INDIRECT, INCIDENTAL, SPECIAL, EXEMPLARY, OR CONSEQUENTIAL DAMAGES (INCLUDING, BUT NOT LIMITED TO, PROCUREMENT OF SUBSTITUTE GOODS OR SERVICES; LOSS OF USE, DATA, OR PROFITS; OR BUSINESS INTERRUPTION) HOWEVER CAUSED AND ON ANY THEORY OF LIABILITY, WHETHER IN CONTRACT, STRICT LIABILITY, OR TORT(INCLUDING NEGLIGENCE OR OTHERWISE) ARISING IN ANY WAY OUT OF THE USE OF THIS SOFTWARE, EVEN IF ADVISED OF THE POSSIBILITY OF SUCH DAMAGE.













## Supplied Accessories

-  Indoor FM antenna --- (1)
-  AM loop antenna --- (1)
-  Remote controller (RC-900M) --- (1)  
Batteries (AA/R6) --- (2)
-  Power cord --- (1)
-  Speaker setup microphone --- (1)

\* The number in parenthesis indicates the quantity. On packaging, the letter at the end of the product name indicates the color.

## How to use the remote controller

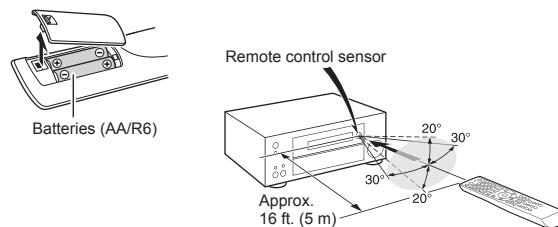

- \* If you do not use the remote controller for a long time, remove the batteries to prevent leakage.
- \* Note that keeping consumed batteries inside may cause corrosion resulting in damage of the remote controller.

# ONKYO

Onkyo Corporation  
Kitahama Chuo Bldg, 2-2-22 Kitahama, Chuo-ku,  
OSAKA 541-0041, JAPAN  
<http://www.onkyo.com/>

### The Americas

Onkyo U.S.A. Corporation  
18 Park Way, Upper Saddle River, N.J. 07458, U.S.A.  
For Dealer, Service, Order and all other Business Inquiries:  
Tel: 201-785-2600 Fax: 201-785-2650  
<http://www.us.onkyo.com/>

For Product Support Team Only:  
1-800-229-1687  
<http://www.us.onkyo.com/>

### Europe

Onkyo Europe Electronics GmbH  
Liegnitzerstrasse 6, 82194 Groebenzell, GERMANY  
Tel: +49-8142-4401-0 Fax: +49-8142-4208-213  
<http://www.eu.onkyo.com/>

### Onkyo Europe Electronics GmbH (UK Branch)

Anteros Building, Odyssey Business Park, West End Road,  
South Ruislip, Middlesex, HA4 6QQ United Kingdom  
Tel: +44 (0)871-200-1996 Fax: +44 (0)871-200-1995

### China

Onkyo China Limited (Hong Kong)  
Unit 1033, 10/F, Star House, No 3, Salisbury Road,  
Tsim Sha Tsui Kowloon, Hong Kong.  
Tel: 852-2429-3118 Fax: 852-2428-9039  
<http://www.hk.onkyo.com/>

### Onkyo China PRC (Mainland)

302, Building 1, 20 North Chaling Rd., Xuhui District,  
Shanghai, China 200032,  
Tel: 86-21-52131366 Fax: 86-21-52130396  
<http://www.cn.onkyo.com/>

### Asia, Oceania, Middle East, Africa

Please contact an Onkyo distributor referring to Onkyo  
SUPPORT site.  
<http://www.intl.onkyo.com/support/>

The above-mentioned information is subject to change  
without prior notice.  
Visit the Onkyo web site for the latest update.

SN 29402034

(C) Copyright 2015 Onkyo Corporation Japan. All rights reserved. Onkyo has the Privacy Policy. You can review it at [<http://www.onkyo.com/privacy/>].



\* 2 9 4 0 2 0 3 4 \*

F1506-0