

ONKYO

TX-SR343

AV RECEIVER

Basic Manual

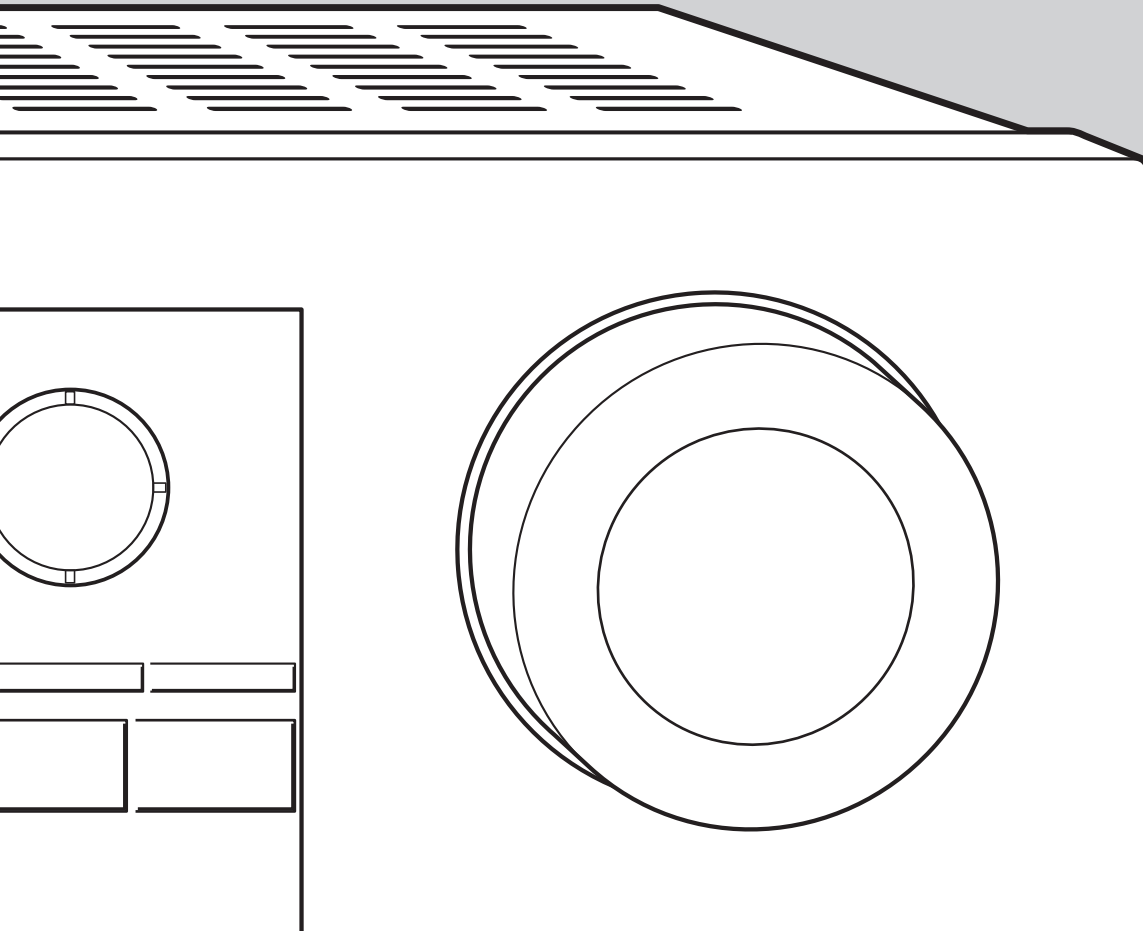

This manual includes information needed when starting up and also instructions for frequently used operations. The Advanced Manual is published on the web for ecological reasons and has more detailed information and advanced settings.

Advanced Manual
found here

<http://www.onkyo.com/manual/txsr343/adv/en.html>



En

Features

- Equipped with 5 ch amplifier
- Equipped with 4K compatible HDMI IN/OUT jacks (To play 4K or 1080p video, use a high speed HDMI cable or high speed HDMI with Ethernet cable)
- Supports the HDMI Standby Through function which allows signal transmission from players to the TV in standby state
- Supports HDCP2.2, a strict copy-protection for providing high quality content
- Supports ARC (Audio Return Channel)
- Supports Bluetooth connection
- A/V Sync Function to correct deviation of audio and video
- 32 bit DSP (Digital Signal Processor) with excellent calculation performance
- Music Optimizer™ for compressed digital music files
- Phase Matching Bass System
- Supports multi-language on-screen displays English, German, French, Spanish, Italian, Dutch, Swedish, Russian*1, Chinese*2

*1 European, Australian and Asian models only

*2 European, Australian, Taiwanese and Asian models only

OSD is not displayed when the input selector is "BLUETOOTH". Use the display on the main unit when operating the unit.

Refer to the back cover for supplied accessories.

Contents

Basic Manual (this manual)

Front Panel.....	3
Rear Panel.....	4
Step 1: Connections.....	5
1 Connecting the TV and Players.....	5
• Connection to TV	5
• Connection with a player that has a HDMI jack	6
• Connection with a player that does not have a HDMI jack.....	6
2 Connecting the AM/FM Antenna.....	6
3 Connecting Speakers.....	7
• Instructions on how to connect speakers	8
Step 2: Setting Up.....	9
1 Turning the Power On	9
2 Making Speaker Setting	9
• Changing speaker configuration	9
• Setting speaker distance.....	10
• Adjusting volume level of speakers.....	10
3 HDMI Setup.....	10
• HDMI CEC (RIHD).....	10
• HDMI Standby Through	10
• ARC (Audio Return Channel).....	10
Step 3: Playing Back	11
1 Basic Operations	11
• Part names and functions of the remote controller	11
• Display	12
2 Bluetooth	12
3 AM/FM Radio	13
4 Quick Setup Menu.....	13
5 Other useful functions	14
Troubleshooting.....	15
Specifications	16
Table of display resolutions	17
Resolutions supported by HDMI.....	17
Supplied Accessories	Back cover

Advanced Manual (on the web)

The Advanced Manual, published as an e-manual on the web, has more detailed information and advanced settings. The Advanced Manual is created in a format that makes it easy to read on a PC or Smartphone. The Advanced Manual has the following content:

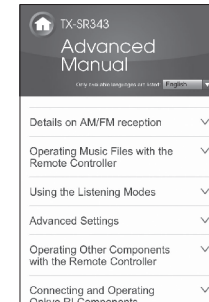

- Details on AM/FM reception
- Operating Music Files with the Remote Controller
- Using the Listening Modes
- Advanced Settings
- Operating Other Components with the Remote Controller
- Connecting and Operating Onkyo RI Components
- Troubleshooting
- Reference Information



Advanced Manual found here
<http://www.onkyo.com/manual/txsr343/adv/en.html>

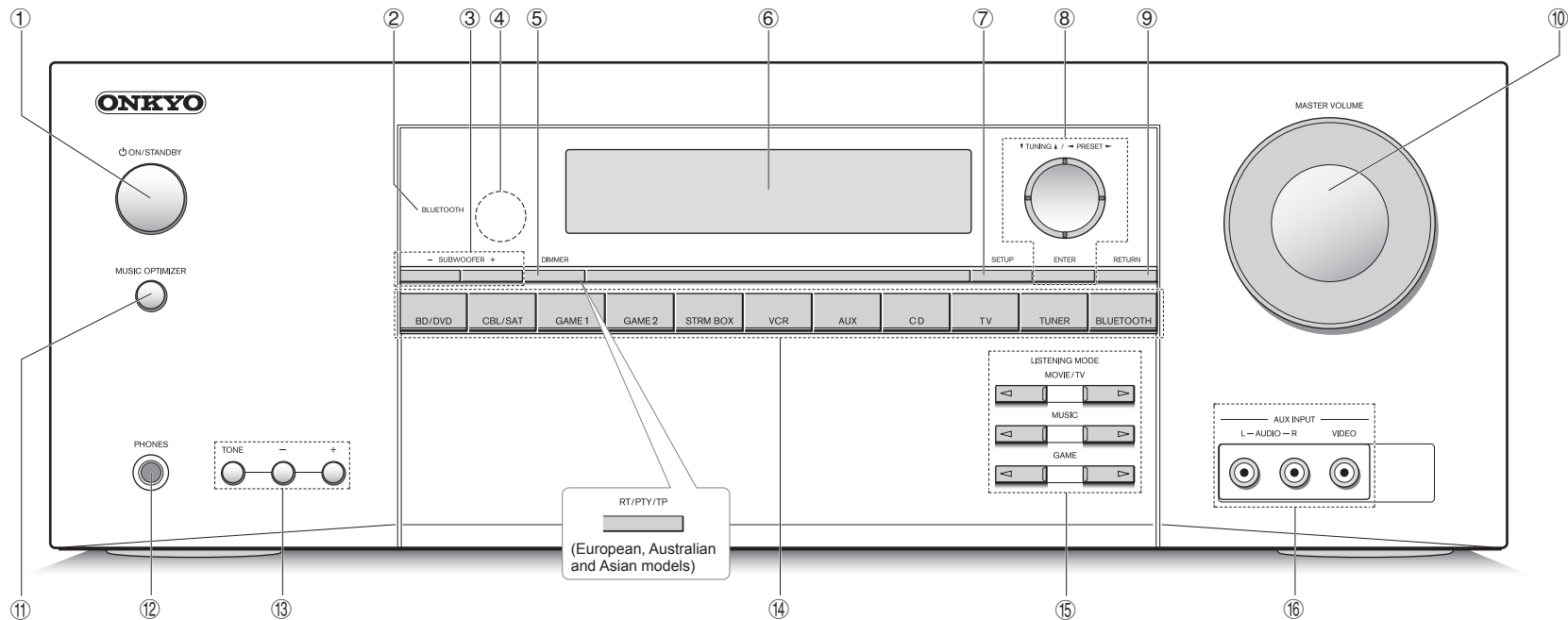

Front Panel

- ① **ON/STANDBY button:** Turns the unit on or into standby mode.
- ② **BLUETOOTH indicator:** Flashes while pairing with a Bluetooth-enabled device is in progress and stays lit when pairing is completed.
- ③ **SUBWOOFER Level buttons:** Adjust the volume of the Subwoofer.
- ④ **Remote control sensor:** Receives signals from the remote controller.
- ⑤ **DIMMER button (North American and Taiwanese models):** Switches the brightness of the display.
RT/PTY/TP button (European, Australian and Asian models): Can be used when receiving the station transmitting text information.
- ⑥ **Display:** Refer to page 12 for details.
- ⑦ **SETUP button:** Used when making settings.
- ⑧ **Cursor buttons, TUNING button, PRESET button and ENTER button:** Move the cursor and confirms the selection. When listening to AM/FM broadcasting, tune in to the station with TUNING or select the registered station with PRESET.
- ⑨ **RETURN button:** Returns the display to the previous state.
- ⑩ **MASTER VOLUME:** Allows you to adjust the volume.
- ⑪ **MUSIC OPTIMIZER button:** Turns on/off the MUSIC OPTIMIZER function that improves the quality of the compressed audio.
- ⑫ **PHONES jack:** Stereo headphones with a standard plug are connected.
- ⑬ **TONE and Tone Level buttons:** Adjust the high tone and low tone.
- ⑭ **Input selector buttons:** Switch the input to be played.
- ⑮ **LISTENING MODE buttons:** Allow you to select the listening mode.
- ⑯ **AUX INPUT VIDEO/AUDIO jacks:** A video camera or such other device is connected.

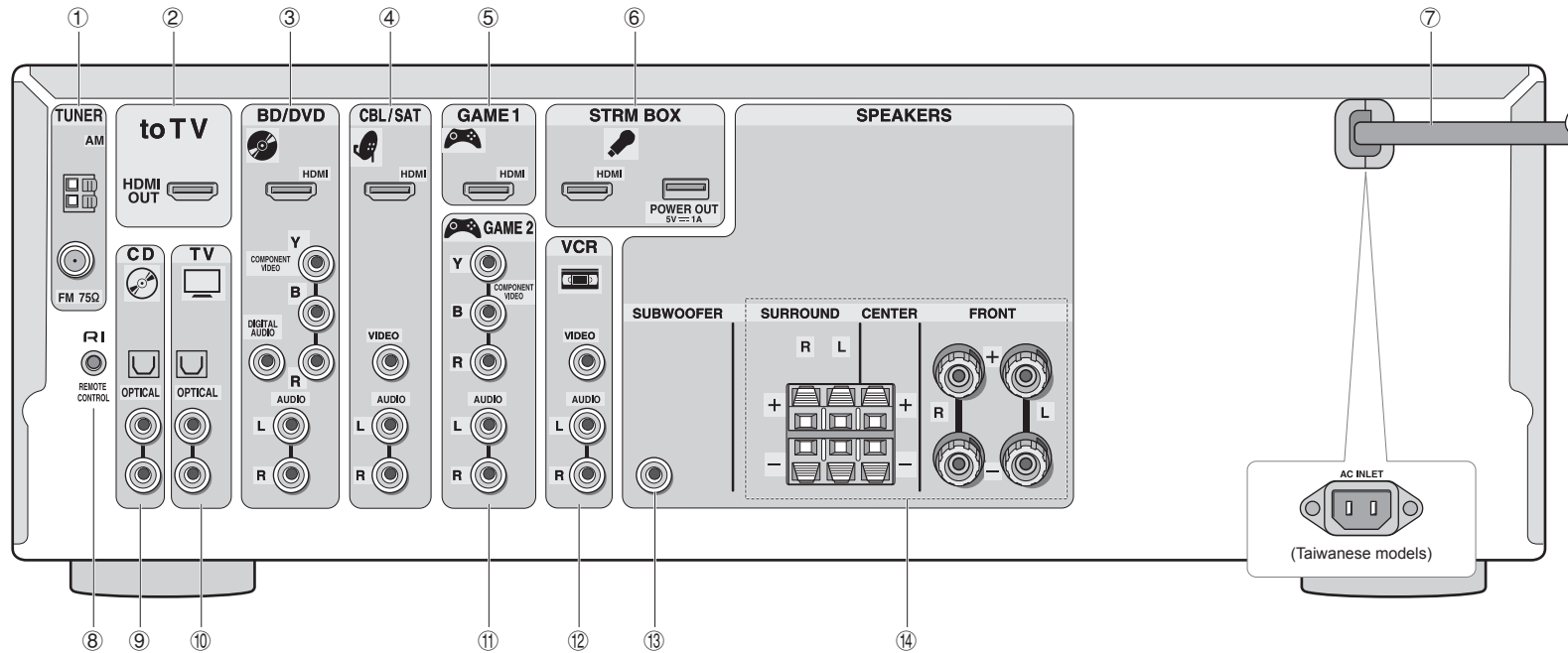

Rear Panel

- ① **TUNER AM/FM (75Ω) terminal:** The supplied antennas are connected.
- ② **to TV jack:** Connect to a TV using a HDMI cable. Change the input selector to "TV" to hear audio from the TV.
* If your TV does not support ARC, you need connection ⑩ in addition to this connection.
- ③ **BD/DVD jacks:** Connect to a Blu-ray Disc Player or DVD Player using a HDMI cable. This corresponds with the "BD/DVD" input selector.
- ④ **CBL/SAT jack:** Connect to a Cable Set-top box using a HDMI cable. This corresponds with the "CBL/SAT" input selector.
- ⑤ **GAME 1 jack:** Connect to a Game console using a HDMI cable. This corresponds with the "GAME 1" input selector.
- ⑥ **STRM BOX jack:** Connect to a Streaming Media Player. When a power supply is required, connect using a USB cable to the POWER OUT port. This corresponds with the "STRM BOX" input selector.
- ⑦ **Power cord (North American, European, Australian and Asian models)**
AC INLET (Taiwanese models): The supplied power cord is connected.
- ⑧ **RI REMOTE CONTROL jack:** An Onkyo product with RI jack can be connected and synchronized with this unit.
- ⑨ **CD jack:** Connect to audio equipment such as a CD Player using a digital optical cable. This corresponds with the "CD" input selector.
- ⑩ **TV jack:** If your TV does not support ARC, you need to connect this jack to the audio output jack on the TV, in addition to connection ②. This corresponds with the "TV" input selector.
- ⑪ **GAME 2 jack:** Connect a game console that has component video jacks. This corresponds with the "GAME 2" input selector.
- ⑫ **VCR jacks:** Connect to a Video Cassette Recorder. This corresponds with the "VCR" input selector.
- ⑬ **SUBWOOFER jacks:** A subwoofer with built-in amplifier is connected.
- ⑭ **SPEAKERS terminals:** Speakers are connected. Up to 5 channels of speakers can be connected.

Step 1: Connections

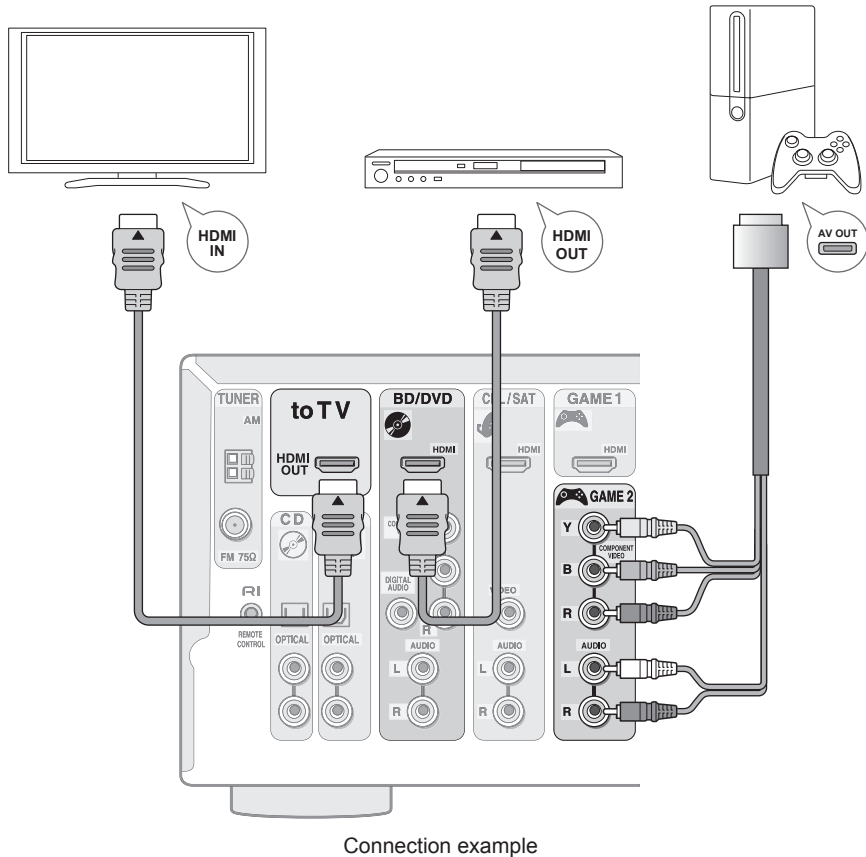

1 Connecting the TV and Players

Before Start

- Connect this unit between the TV and player.
 - To select the source to play, select the input selector button with the same name as the jack to which it is connected. Input switches automatically when you have connected equipment that conforms to the CEC (Consumer Electronics Control) standard to this unit using a HDMI cable. (*)
 - This allows audio and video signal transmission from players to the TV even if this unit is in standby. (HDMI Standby Through function) (*)
 - The power cord must be connected only after all other connections are completed.
- * It is necessary to make appropriate settings to enable this function. See "3 HDMI Setup" of "Step 2: Setting Up".

Connection to TV

Connect the "to TV" jack and the HDMI IN jack of the TV with a HDMI cable. This is the only connection necessary with a TV that supports ARC. If your TV does not support ARC, you need to connect the "TV" jack to the audio output jack on the TV with a digital optical cable or an RCA cable, in addition to this connection to the "to TV" jack.

- * This function enables you to play the audio from the TV through the speakers of this unit just by connecting this unit and the TV with a single HDMI cable. To use the ARC function, connect to the ARC compatible HDMI jack of the TV and make appropriate settings on this unit. See "3 HDMI Setup" of "Step 2: Setting Up".

- Audio connection with a TV not supporting ARC

* Select an appropriate connection for your TV.

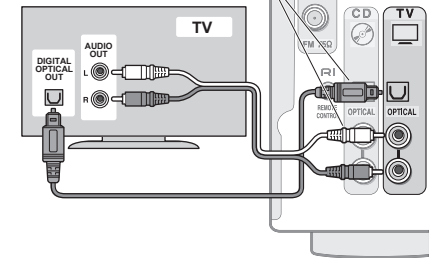

Cable used for connection (sold separately)

- HDMI cable
- Component video cable
- Composite video cable
- Digital coaxial cable
- Digital optical cable
- Analog audio (RCA) cable

Connection with a player that has a HDMI jack

Connect to the "BD/DVD", "CBL/SAT", "GAME 1", and "STRM BOX" jacks using a HDMI cable. Connect the equipment to the corresponding jack, for example a Blu-ray Disc Player to "BD/DVD", so that it is easy for you when selecting with the input selector. Connect a Streaming Media Player to the "STRM BOX" jack. When a power supply is required, connect using a USB cable to the POWER OUT port. (✳)

✳ The POWER OUT jack supports a 5V/1A power supply.

Connection with a player that does not have a HDMI jack

Connect equipment with video output jacks to the "BD/ DVD", "CBL/SAT", "GAME 2", and "VCR" jacks. Connect with component video cable or composite video cable for video signals and digital coaxial cable or RCA cable for audio signals.

Connect audio equipment such as a CD Player using a digital optical cable or an RCA cable to the "CD" jack.

- Video signals input to the component video input or the composite video input will be upconverted to HDMI signals and then output from the "to TV" jack. When upconverting video signals input to the component video input for output from the HDMI OUT jack, set the output resolution of the player to 480i or 576i. If the input has 480p/576p or higher resolution, a message prompting you to change the resolution setting will appear. If your player does not support 480i or 576i output, use the composite video jack.
- Connection with a digital coaxial cable or digital optical cable is necessary for playback of digital surround sources such as Dolby Digital. The digital in optical jack of the unit has a cover, push in the cable against the cover as it is turned inside.

2 Connecting the AM/FM Antenna

Connect the antennas to listen to AM/FM broadcast. When listening to the broadcast for the first time, adjust the antenna position and orientation to get the best reception.

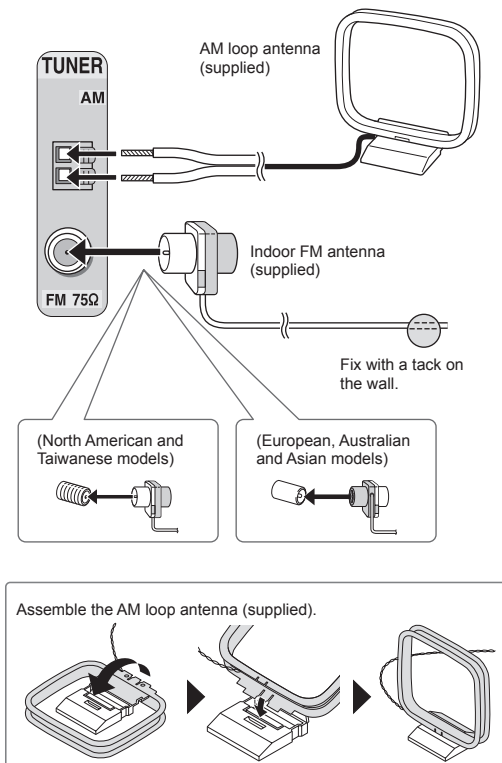

3 Connecting Speakers

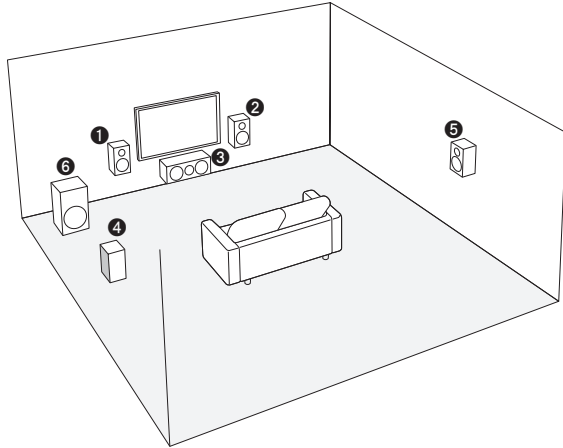

- 1 2 Front speakers
- 3 Center speaker
- 4 5 Surround speakers
- 6 Subwoofer

Important:
Connect speakers with 6 Ω to 16 Ω impedance. Using a speaker with less impedance than the supported value may result in failure.

Characteristics of speaker types

- 1 2 output front stereo sound and 3 outputs center sound such as dialogs and vocals.
- 4 5 create back sound field.
- 6 reproduces bass sounds and creates rich sound field.

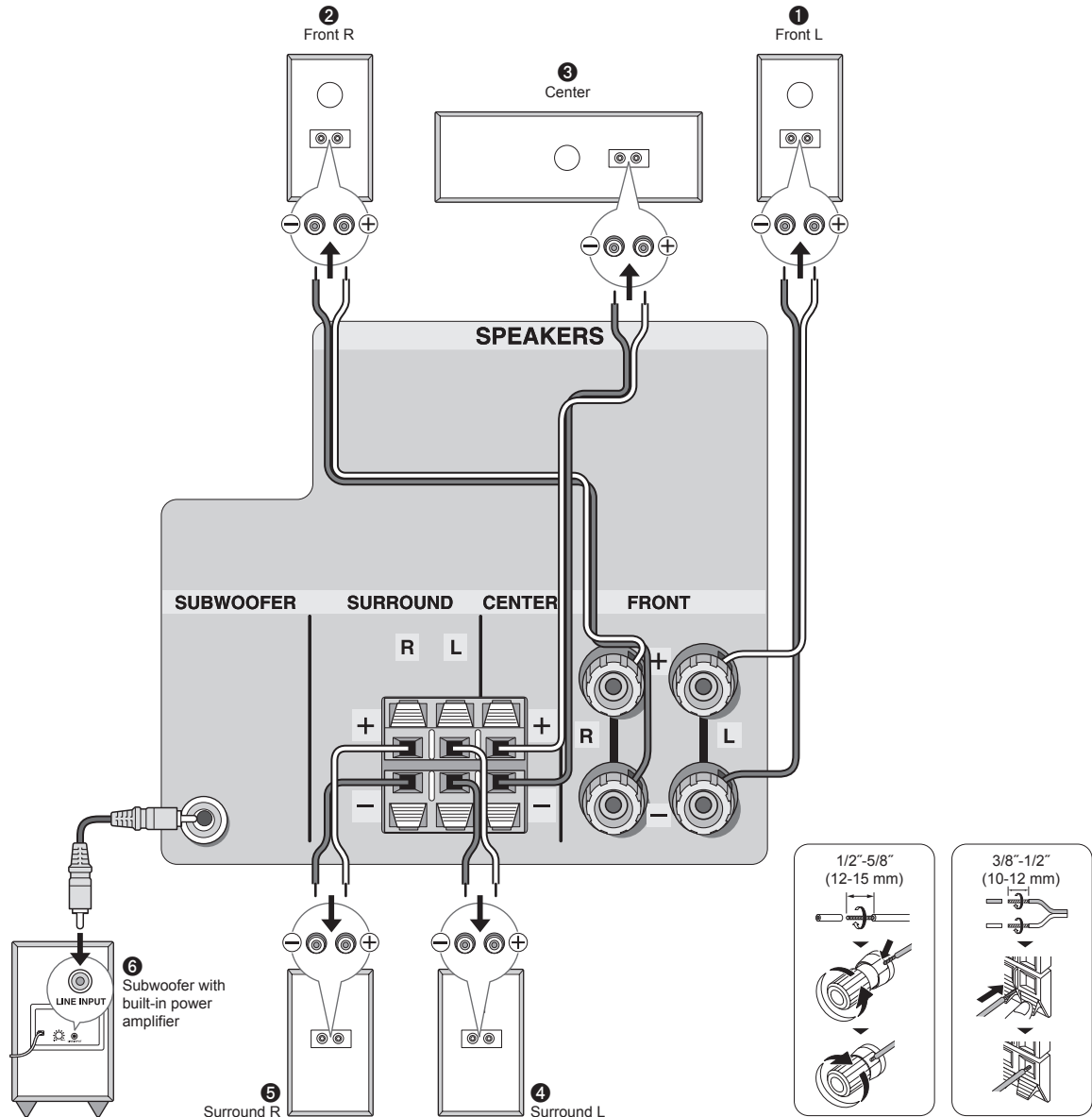

Instructions on how to connect speakers

Cut and remove the plastic coating from the end of the speaker cable, twist the core and connect it to the terminal. Be sure to make correct connection between the unit's jacks and speaker's jacks (+ to + and - to -) for each channel. If connection is wrong, a bass sound may become poor due to reverse phase. The subwoofer jack supports connection of a subwoofer with built-in power amplifier. Set the cut-off filter selection switch of the subwoofer to DIRECT. If the subwoofer does not have a cut-off filter selection switch but has a cut-off frequency adjusting dial, turn it to the maximum frequency. If your subwoofer does not have built-in power amplifier, you can connect a power amplifier between the unit and the subwoofer.

- The speaker setting is 5.1 ch at the time of purchase. Change the setting when you use a configuration other than 5.1 ch.
- Short-circuiting the + cable and - cable or contacting the cable core to the rear panel of the unit may cause failure. Also do not connect two or more cables to one speaker terminal or one speaker to several terminals.

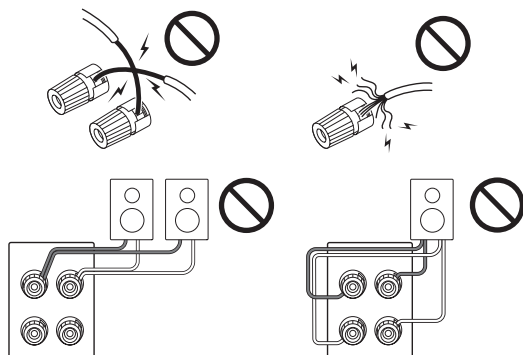

When using commercially available banana plugs: tighten the speaker terminals to the end and then insert the banana plugs. Do not insert the core of speaker cable directly into the hole for banana plug of speaker terminal. (North American models)

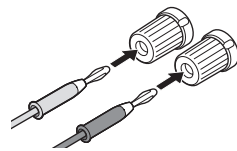

Step 2: Setting Up

● **Operation:** Use the remote controller of this unit to operate the menus shown on the TV screen. To display the guidance, you need to make HDMI connection between the unit and TV. Select the item with the cursor buttons of the remote controller and press ENTER to confirm your selection. To return to the previous screen, press RETURN.

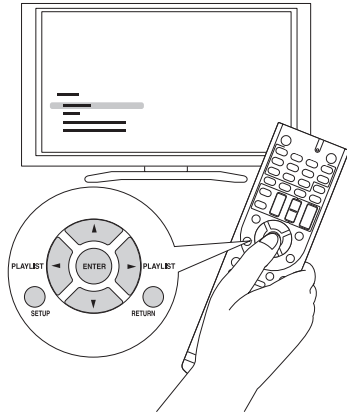

1 Turning the Power On

Connect the power cord to the outlet (*). Press **ON/STANDBY** on the main unit or **RECEIVER** on the remote controller to turn the unit on or to standby mode.

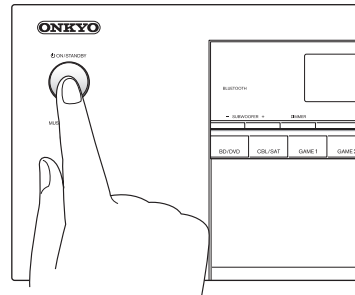

- When the unit is turned on, a large instantaneous current may flow affecting functionality of the computer and other devices. It is recommended to use a separate outlet from that for the computer or such other sensitive devices.

* Taiwanese models include removable power cords. Connect the power cord to AC INLET of the unit and then connect to the outlet. Always disconnect the outlet side first when disconnecting the power cord.

2 Making Speaker Setting

The speaker configuration of this unit is set to 5.1 ch by default. Refer to the following sections to change settings so that you can use the unit in a different environments such as a configuration without center speaker, surround speaker or subwoofer.

- If the settings do not match the actual speaker configuration, audio playback may not be performed correctly. Check your speaker configuration and make correct settings.
- These settings cannot be changed if headphones are connected or audio is output from the speakers of the TV.

Changing speaker configuration

1. After pressing **RECEIVER**, press **SETUP** on the remote controller.
2. Select **"2. Speaker"** with the cursor, and press **ENTER**.
3. Select **"Configuration"** with the cursor, and press **ENTER**.

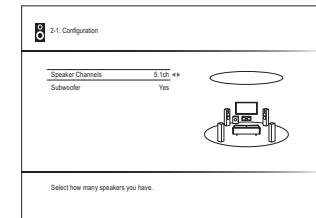

Use the cursors **◀/▶** to configure the number of connected speaker channels and the existence of a subwoofer. When setting is complete, press **SETUP** to close the menu screen.

- You can change the size, crossover frequency, and Double Bass settings for each speaker in "Crossover".

Setting speaker distance

1. After pressing **RECEIVER**, press **SETUP** on the remote controller.
2. Select **"2. Speaker"** with the cursor, and press **ENTER**.
3. Select **"Distance"** with the cursor, and press **ENTER**.

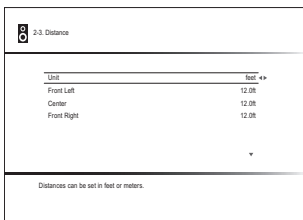

Use the cursors **◀/▶** to configure the distance from each speaker to the listening position. When setting is complete, press **SETUP** to close the menu screen.

- Some setting items may not be selectable depending on the settings of "Configuration".

Adjusting volume level of speakers

1. After pressing **RECEIVER**, press **SETUP** on the remote controller.
2. Select **"2. Speaker"** with the cursor, and press **ENTER**.
3. Select **"Level Calibration"** with the cursor, and press **ENTER**.

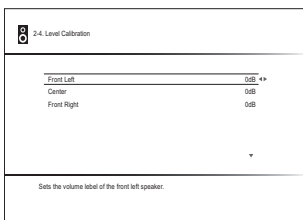

Move the cursor with **◀/▶** buttons and change the volume level of each speaker. A test tone will be output each time you change the level. Select the desired level. When setting is complete, press **SETUP** to close the menu screen.

- This setting cannot be changed when muting is enabled.

- Some setting items may not be selectable depending on the settings of "Configuration".

3 HDMI Setup

The unit supports the linked system function such as power on/off link when connected via HDMI cable with a CEC (Consumer Electronics Control) compliant TV or player. You need to change the default setting to use the linked system function, HDMI Standby Through function and ARC (Audio Return Channel) function.

HDMI CEC (RIHD)

The following linked operations are possible with connected equipment when the CEC function is enabled.

- Turning the TV to standby mode will turn the unit to standby mode.
- On the TV side, it is possible to set whether to output audio from the speakers connected to the unit or from the TV's speakers.
- Starting playback of a CEC compliant player/recorder will automatically switch the unit's input to the HDMI input of the player/recorder. If the unit is in standby mode, it will automatically be turned on.

It is also possible to control the connected CEC compliant equipment with the remote controller of the unit. For details, see the Advanced Manual.

- * RIHD is a name for the linked system function of Onkyo's CEC compliant products.

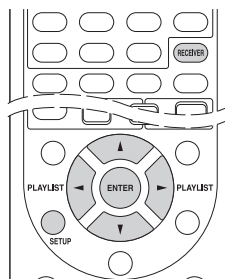

1. After pressing **RECEIVER**, press **SETUP** on the remote controller.
2. Select **"5. Hardware"** with the cursor and press

ENTER.

3. Select **"HDMI"** with the cursor and press **ENTER**.
4. Select **"HDMI CEC (RIHD)"** with the cursor and select **"On"**.

- When setting is complete, press **SETUP** to close the menu screen.

HDMI Standby Through

The function allows transmission from players to the TV even if the unit is in standby. Setting the HDMI CEC (RIHD) setting mentioned above to "On" enables this setting automatically.

- Power consumption in standby mode increases when the HDMI Standby Through function is enabled.

ARC (Audio Return Channel)

Simple connection to the ARC compatible TV using a single HDMI cable allows to listen to the TV audio signals from the speakers connected to the unit. Setting the HDMI CEC (RIHD) setting mentioned above to "On" enables the "Audio Return Channel" setting automatically.

Audio output of connected players

To enjoy digital surround sound including Dolby Digital and DTS, audio output should be set to "Bitstream output" on the connected Blu-ray Disc Player or other device.

Depending on the settings on the Blu-ray Disc Player, there may be cases when Dolby TrueHD and DTS-HD Master Audio is not output according to the format of the source.

In this case, in the Blu-ray Disc Player settings try setting "BD video supplementary sound" (or secondary sound) to "Off".

Change the listening mode after changing the setting to confirm.

Step 3: Playing Back

1 Basic Operations

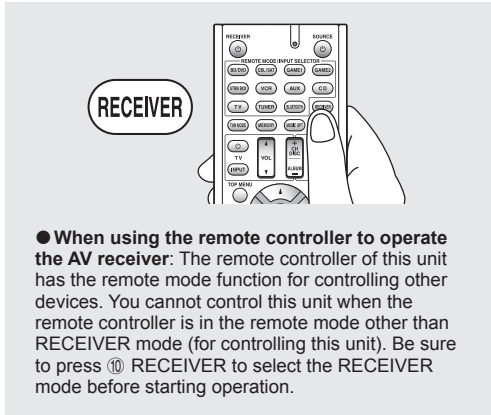

1. Turning the power on.

Press ① **RECEIVER** on the remote controller to turn the power on.

- Switch the input on the TV to that assigned to the unit. Use the TV's remote controller.

2. Select the input on the unit.

Press the ② **INPUT SELECTOR** for the player you want to listen to. Press TV to listen to the TV's sound. You can also use the input selector buttons on the main unit.

- Input will automatically be selected if the TV or player is CEC compliant and connected to the unit with HDMI cable.

3. Select the desired listening mode.

After pressing ⑩ **RECEIVER**, press the ⑦ listening mode buttons to switch the mode so that you can enjoy different listening modes.

4. Adjust the volume with ⑫ **VOL.**

Part names and functions of the remote controller

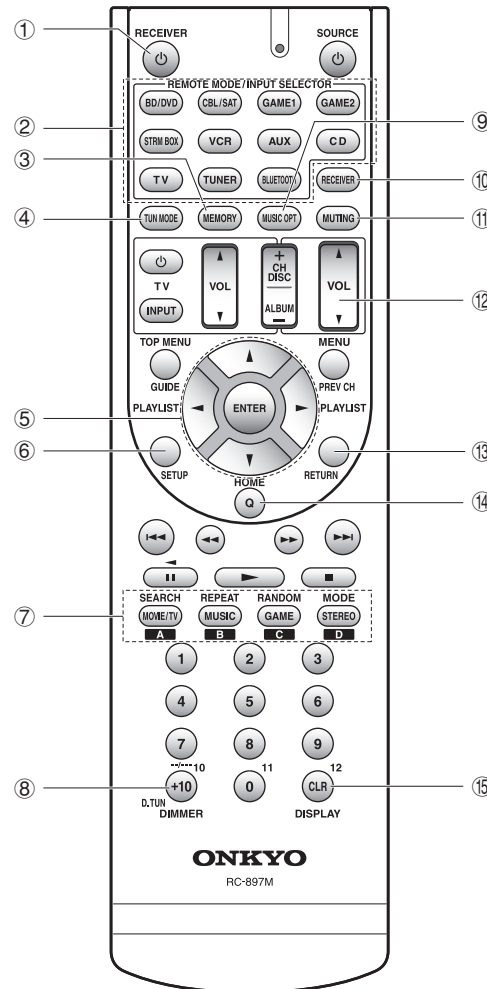

① **RECEIVER button**: Turns the unit on or into standby mode.

② **REMOTE MODE/INPUT SELECTOR buttons**: Switch the input to be played. Furthermore, by registering a particular remote control code to a button, you can switch the remote control mode to operate other equipment by pressing that button.

③ **MEMORY button**: Registers a radio station.

④ **TUN MODE button**: Switches the tuning mode.

⑤ **Cursor buttons and ENTER button**: Move the cursor and confirms the selection.

⑥ **SETUP button**: Displays the screen for making various settings for this unit.

⑦ **Listening mode buttons**: Allow you to select the listening mode.

MOVIE/TV button: You can select a listening mode suitable for movies and TV programs.

MUSIC button: You can select a listening mode suitable for music.

GAME button: You can select a listening mode suitable for games.

STEREO button: You can select a listening mode for stereo and all channel stereo sources.

- For details on the listening modes, see the Advanced Manual.

⑧ **DIMMER button**: Switches the brightness of the display.

⑨ **MUSIC OPT button**: Turns on/off the MUSIC OPTIMIZER function that improves the quality of the compressed audio.

⑩ **RECEIVER button**: Switches the remote controller to the mode for operating this unit.

⑪ **MUTING button**: Temporarily mutes audio. Press again to cancel muting.

⑫ **VOLUME buttons**: Allow you to adjust the volume. This button also cancels the muting.

⑬ **RETURN button**: Returns the display to the previous state.

⑭ **Q button**: Displays the Quick Setup menu that allows you to quickly access the frequently used setting items including sound quality adjustment.

⑮ **DISPLAY button**: Switches the information on the display.

Display

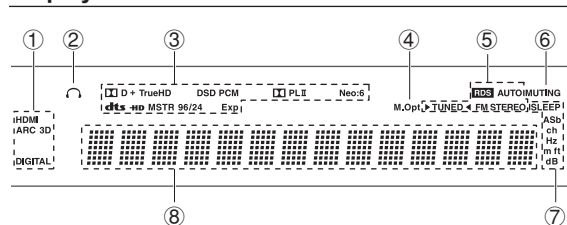

- ① Lights in the following conditions: "HDMI": HDMI signals are input and HDMI input selector is selected. This lights faintly when the HDMI Standby Through function is enabled and the unit is in standby. / "ARC": Audio signals are input from ARC compatible TV and TV input selector is selected. / "3D": Input signals are 3D. / "DIGITAL": Digital signals are input and selected.
- ② Stays lit when headphones are connected.
- ③ Lights according to the type of input digital signals and the listening mode.
- ④ Stays lit when Music Optimizer is enabled.
- ⑤ Lights in the following conditions. "AUTO": Tuning mode is auto. / "▶TUNED◀": Receiving AM/FM radio. ▶◀ flashes while tuning is automatically performed. / "FM STEREO": Receiving FM stereo. / "RDS" (European, Australian and Asian models): Receiving RDS broadcasting.
- ⑥ "MUTING": Flashes when muting is on.
- ⑦ Lights in the following conditions. "SLEEP": Sleep timer has been set. This lights faintly when the Power Out at Standby for STRM BOX function is enabled and the unit is in standby. / "ASb" (Auto Standby): Auto Standby is on. / "ch": Channel is being set. / "Hz": Crossover frequencies are being set. / "m/ft": Speaker distances are being set. / "dB": Speaker volume is being set.
- ⑧ Displays various information of the input signals. Pressing DISPLAY displays the type of input digital signals and the listening mode.

2 Bluetooth

You can wirelessly enjoy music files stored in a smartphone or other Bluetooth-enabled device. The coverage area is 48 feet (15 meters).

- The Bluetooth-enabled device needs to support the A2DP profile.
- Note that connection is not always guaranteed with all Bluetooth-enabled devices.

■ Pairing

Pairing is necessary when connecting the Bluetooth-enabled device for the first time. Before starting the procedure, learn how to enable the Bluetooth setting function and to connect with other devices on the Bluetooth-enabled device.

1. Press BLUETOOTH on the remote controller.

The unit begins pairing and "Now Pairing..." is displayed.

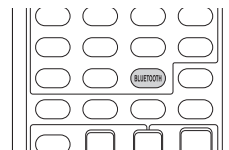

2. While "Now Pairing..." is on the display, complete connection on the Bluetooth-enabled device in the nearby area within about 1 minute.

If the name of this unit is displayed on the Bluetooth-enabled device's display, select this unit. Pairing will end after a short time.

- If a password is requested, enter "0000".
- You can pair with another Bluetooth-enabled device by pressing and holding the BLUETOOTH button until "Now Pairing..." is on the display. This unit can store the data of up to 8 paired devices.

■ Playing Bluetooth-enabled devices

If the unit is on and the Bluetooth-enabled device is connected, the input will be automatically switched to BLUETOOTH. Play music in this state.

For details on using the remote controller for these operations, see the Advanced Manual.

- If the volume setting on the Bluetooth-enabled device is low, the sound will not be output from this unit.
- Due to the characteristics of Bluetooth wireless technology, the sound produced on this unit may slightly be behind the sound played on the Bluetooth-enabled device.
- The on-screen displays are not displayed when the OSD language is set to Chinese. Operate by confirming the display on the main unit. (European, Australian, Taiwanese and Asian models)

3 AM/FM Radio

The Basic Manual explains the method using automatic tuning. For manual tuning, see the Advanced Manual.

1. Press **TUNER** on the remote controller several times to select either "AM" or "FM".
2. Press **TUN MODE** so that the "AUTO" indicator on the display lights.
3. Press the **▲/▼** cursor buttons.

The automatic tuning to a radio station starts. Searching stops when one is tuned. When tuned into a radio station, the "▶TUNED◀" indicator on the display lights. The "FM STEREO" indicator lights if the radio station is an FM radio station.

- Alternatively you can press **▼TUNING▲** on the main unit.

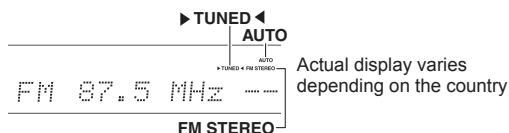

Registering a radio station: You can register up to 40 of your favorite AM/FM radio stations.

1. Tune into the AM/FM radio station you want to register.
2. Press **MEMORY** on the remote controller so that the preset number on the display flashes.
3. Press **CH +/-** several times to select a number between 1 and 40 while the preset number is flashing (about 8 seconds).
 - Alternatively you can press **◀PRESET▶** on the main unit.
4. Press **MEMORY** again to register the station. When registered, the preset number stops flashing. To select a preset radio station, press **◀PRESET▶** on the main unit or **CH +/-** on the remote controller.
 - To delete a preset station, after selecting the preset station you want to delete, press **MEMORY** on the remote controller, and with the preset number flashing on the display, press **CLR** on the remote controller.

AM/FM frequency step setting

It may be necessary for you to change the frequency step to tune the radio in your area. Change the step with the following procedure. Note that when this setting is changed, all radio presets are deleted.

1. After pressing **(RECEIVER)** on the remote controller, press **SETUP**.
2. Select "5. Hardware" with the cursor and press **ENTER**.
3. Select "Tuner" with the cursor and press **ENTER**.
4. Select "AM / FM Frequency Step" (North American and Taiwanese models) or "AM Frequency Step" (European, Australian and Asian models) with the cursor and select the frequency step for your area.

(For Taiwanese models only)

The setting is "10 kHz / 0.2 MHz" at the time of purchase. Please change it to "9 kHz / 0.05 MHz".

4 Quick Setup Menu

You can perform common settings on the TV screen while playing.

1. Press **Q** on the remote controller.

The Quick Setup menu is displayed on the connected TV's screen.

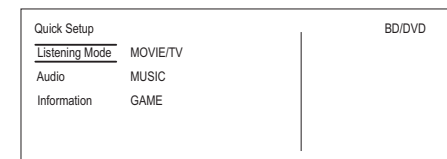

2. Select the item with the cursors on the remote controller and then press **ENTER**.

- To return to the previous screen, press **RETURN**.

3. Select the setting with the cursors of the remote controller.

■ **Listening Mode:** Select the listening mode from the categories of "MOVIE/TV", "MUSIC" and "GAME". After selecting the Listening Mode, press **ENTER** button to confirm.

- It cannot be set when audio is played from the TV's speakers.

■ **Audio:** You can perform various audio settings including audio quality and speaker level adjustment.

- You cannot select this item when audio is output from the TV's speakers.

Bass, Treble: Adjust volume of the front speaker.

- It cannot be set if the listening mode is Direct.

Phase Matching Bass: Suppress phase shift in the midrange to enhance bass sound. Thus smooth and powerful bass sound can be obtained.

- It cannot be set if the listening mode is Direct.

Center Level, Subwoofer Level: Adjust the speaker level while listening to the sound. The adjustment you made will be reset to the previous status when you turn the unit to standby mode.

- Changes may not be possible depending on the speaker settings.

- This setting is not possible during MUTING or when using headphones.

A/V Sync: If the video is behind the audio, you can delay the audio to offset the gap. Different settings can be set for each input selector.

- It cannot be set if the listening mode is Direct.

Music Optimizer: Improve the quality of the compressed audio. Playback sound of lossy compressed files such as MP3 will be improved. The setting can be separately set to each input selector.

- The setting is effective in the signals of 48 kHz or less. The setting is not effective in the bitstream signals.
- It cannot be set if the listening mode is Direct.

Late Night: Make small sounds to be easily heard. It is useful when you need to reduce the volume while watching a movie late night. You can enjoy the effect only with Dolby Digital, Dolby Digital Plus, and Dolby TrueHD input sources.

- Turning the unit to standby mode will set the setting to "Off". In case of Dolby TrueHD, the setting will be set to "Auto".
- If "Loudness Management" is set to "Off", this function is not available when playing Dolby Digital Plus or Dolby TrueHD.

Cinema Filter: Adjust the soundtrack that was processed to enhance its treble, in order to make it suitable for home theater.

- This function can be used in the following listening modes: Dolby Digital, Dolby Digital Plus, Dolby PLII Movie, Dolby TrueHD, Multichannel, DSD, DTS, DTS Neo:6 Cinema, DTS 96/24, DTS-HD High Resolution Audio, DTS-HD Master Audio, DTS Express.

■ Information:

Audio: Displays the audio input source, format, number of channels, sampling frequency, listening mode, and number of output channels.

Video: Displays information such as the video input source, resolution, color space, color depth, 3D information, Aspect and output.

Tuner: Displays information such as the band, frequency, and preset number. This is displayed only when "TUNER" is selected as the input source.

5 Other useful functions

To adjust the sound quality

It is possible to enhance or moderate the bass and treble of front speakers. Press TONE on the main unit several times to select the desired setting from "Bass", "Treble" and "Phase Matching Bass", and adjust with +/-.

- It cannot be set if the listening mode is Direct.
- "Bass":** Allows you to enhance or moderate the bass.
"Treble": Allows you to enhance or moderate the treble.
"Phase Matching Bass": Allows you to keep the clear midrange and effectively enhance the bass.

Checking the Input Format

Press DISPLAY on the remote controller several times to switch the display of the main unit in order of:

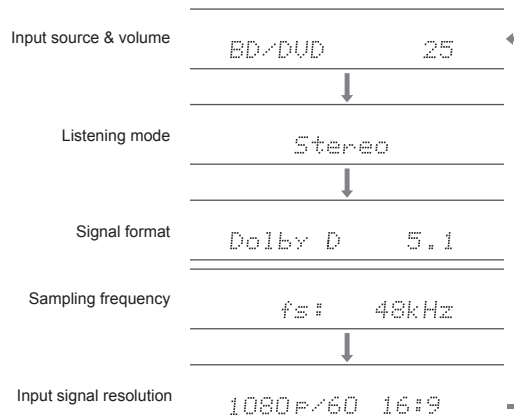

- If "Dolby D 5.1" is displayed in Signal format, the Dolby Digital 5.1 ch signals are being input. When listening to AM/FM radio, the band, frequency and preset number are displayed.

Playing Audio and Video from Separate Sources

It is possible to play audio and video from different sources. For example, you can play audio from the CD player and video from the BD/DVD player. In this case, press BD/DVD and then CD. Then start playback on the BD/DVD

player and CD player. This function is effective when an input with audio only has been selected (CD, TUNER or BLUETOOTH). (*)

- * When BLUETOOTH is selected, press MODE on the remote controller.

Troubleshooting

Before starting the procedure

Problems may be solved by simply turning the power on/off or disconnecting/connecting the power cord, which is easier than working on the connection, setting and operating procedure. Try the simple measures on both the unit and the connected device. If the problem is that the video or audio is not output or the HDMI linked operation does not work, disconnecting/connecting the HDMI cable may solve it. When reconnecting, be careful not to wind the HDMI cable since if wound the HDMI cable may not fit well. After reconnecting, turn off and on the unit and the connected device.

The AV receiver turns off unexpectedly.

- The AV receiver will automatically enter standby mode when Auto Standby or Sleep Timer is set and launched.
- The protection circuit may have been activated. If this is the case, when you turn the unit on again, "AMP Diag Mode" will appear on the main unit's display. The unit will then enter a mode that detects abnormal conditions. If no problems are detected, "AMP Diag Mode" will disappear and the unit will return to a normal state. If "CHECK SP WIRE" appears on the display, the speaker cables may be short-circuited. Turn the unit off, and check to see if the cable core of any of the speaker cables is in contact with that of another speaker cable or with the rear panel. After that, turn the unit on again. If "NG" appears, unplug the power cord immediately and contact your Onkyo dealer.

There's no sound, or it's very quiet.

- A wrong input selector button has been selected. Select a correct input for the player. Also check that muting is not on.
- Not all listening modes use all speakers.

There's no picture.

- A wrong input selector button has been selected.
- To display video from the connected player on the TV screen while the unit is in standby, you need to enable HDMI Standby Through function.
- When the TV image is blurry or unclear, power cord or connection cables of the unit may have interfered. In that case, keep distance between TV antenna cable and cables of the unit.

Video and audio are out of synchrony.

- Video may be delayed relative to audio depending on the settings and connections with your TV. Adjust in "Step 3: Playing Back", "4 Quick Setup Menu", "A/V Sync".

Cannot play digital surround.

- To enjoy digital surround sound including Dolby Digital and DTS, audio output should be set to "Bitstream output" on the connected Blu-ray Disc Player or other device.

Cannot output audio according to the format of the source.

- If you cannot output audio according to the format of the source (Dolby TrueHD, DTS-HD Master Audio, etc.), in the Blu-ray Disc Player settings try setting "BD video supplementary sound" (or secondary sound) to "Off". Change the listening mode for each source after changing the setting to confirm.

HDMI control does not function correctly.

- Set the CEC link function of the unit to on. It is also necessary to make the HDMI linked system setting on the TV. See the TV's instruction manual for details.

Resetting the unit

Resetting the unit to the status at the time of shipment may solve the problem. If the measures above do not solve the problem, reset the unit with the following procedure. If you reset the unit status, your preferences will be reset to the defaults. Note them down before starting reset.

How to reset:

1. While holding down CBL/SAT on the main unit (note that step 2 must be performed with this button pressed down)
2. Press \odot ON/STANDBY on the main unit. ("Clear" appears on the display and the unit returns to standby.)
 - Do not unplug the power cord until "Clear" disappears from the display.

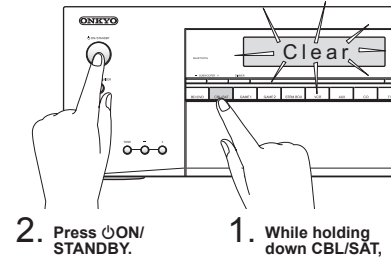

How to reset the remote controller:

1. While holding down RECEIVER on the remote controller, press Q until the remote indicator stays lit (about 3 seconds).
2. Within 30 seconds, press RECEIVER again.

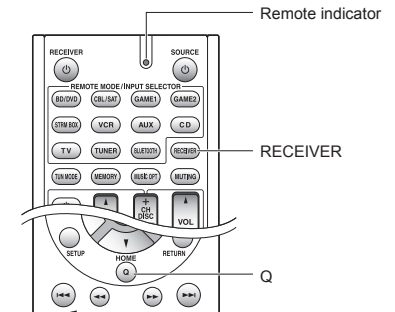

Specifications

Amplifier Section

Rated Output Power (North American)

With 8 ohm loads, both channels driven, from 20-20,000 Hz; rated 65 watts per channel minimum RMS power, with no more than 0.7% total harmonic distortion from 250 milliwatts to rated output.

Surround Mode Output Power (*)
(6 ohms, 1 kHz THD 0.9%) 110 W per channel

* Reference output for each speakers.

Depending on the source and the listening mode settings, there may be no sound output.

Rated Output Power (Others)

5 ch x 100 W at 6 ohms, 1 kHz, 1 ch driven of 1% (IEC)

Maximum Effective Output Power

5 ch x 120 W at 6 ohms, 1 kHz, 1 ch driven (JEITA) (Asian)

Dynamic Power (*)

* IEC60268-Short-term maximum output power

160 W (3 Ω, Front)

125 W (4 Ω, Front)

85 W (8 Ω, Front)

THD+N (Total Harmonic Distortion+Noise)

0.08% (20 Hz - 20 kHz, half power)

Input Sensitivity and Impedance (Unbalance)

200 mV/47 kΩ (LINE, 1 kHz 100 W/8 Ω)

Rated RCA Output Level and Impedance

1 V/470 Ω (SUBWOOFER PRE OUT)

Frequency Response

10 Hz - 100 kHz/+1 dB, -3 dB (Direct mode)

Tone Control Characteristics

±10 dB, 20 Hz (BASS)

±10 dB, 20 kHz (TREBLE)

Signal to Noise Ratio

100 dB (LINE, IHF-A)

Speaker Impedance

6 Ω - 16 Ω

Video Section

Signal level

1.0 Vp-p/75 Ω (Component Y)

0.7 Vp-p/75 Ω (Component Pb/Cb, Pr/Cr)

1.0 Vp-p/75 Ω (Composite)

Maximum resolution supported by component video

480i/576i

Tuner Section

FM Tuning Frequency Range

87.5 MHz - 107.9 MHz

(North American and Taiwanese)

87.5 MHz - 108.0 MHz, RDS (Others)

AM Tuning Frequency Range

522/530 kHz - 1611/1710 kHz

Preset Channel

40

Bluetooth Section

Communication system

Bluetooth Specification version 2.1 +EDR (Enhanced Data Rate)

Maximum communication range

Line of sight approx. 15 m (*)

Frequency band

2.4 GHz band

Modulation method

FHSS (Freq Hopping Spread Spectrum)

Compatible Bluetooth profiles

A2DP 1.3 (Advanced Audio Distribution Profile)

AVRCP 1.5 (Audio Video Remote Control Profile)

Supported Codescs

SBC

Transmission range (A2DP)

20 Hz - 20,000 Hz (Sampling frequency 44.1 kHz)

* The actual range will vary depending on factors such as obstacles between devices, magnetic fields around a microwave oven, static electricity, cordless phone, reception sensitivity, antenna's performance, operating system, software application, etc.

General

Power Supply

AC 120 V, 60 Hz (North American and Taiwanese)

AC 220 - 240 V, 50/60 Hz (Others)

Power Consumption

3.8 A (North American and Taiwanese)

370 W (Others)

0.15 W (Stand-by, North American and Taiwanese)

0.3 W (Stand-by, Others)

50 W (No-sound, North American and Taiwanese)

45 W (No-sound, Others)

Dimensions (W x H x D)

435 mm x 160 mm x 328 mm

17-1/8" x 6-5/16" x 12-15/16"

Weight

7.8 kg (17.2 lbs.) (North American and Taiwanese)

8.0 kg (17.6 lbs.) (Others)

● HDMI

Input

BD/DVD, CBL/SAT, GAME 1, STRM BOX

Output

HDMI OUT (to TV)

Video Resolution

4K 60 Hz (RGB/YCbCr 4:4:4/YCbCr 4:2:2, 24 bit)

Audio Format

Dolby TrueHD, Dolby Digital Plus, Dolby Digital, DTS-HD Master Audio,

DTS-HD High Resolution Audio, DTS 96/24, DTS, DTS Express, DSD,

Multichannel PCM (up to 8ch)

Supported

3D, Audio Return Channel, Deep Color, x.v.Color™, LipSync, CEC, 4K,

Extended Colorimetry (sYCC601, Adobe RGB, Adobe YCC601),

Content Type, 3D Dual View, 21:9 Aspect Ratio Video Format

● Video Inputs

Component

COMPONENT VIDEO (BD/DVD, GAME 2)

Composite

VIDEO (CBL/SAT, VCR), AUX INPUT VIDEO (front)

● Audio Inputs

Digital

OPTICAL (CD, TV)

DIGITAL AUDIO (BD/DVD)

Analog

AUDIO (BD/DVD, CBL/SAT, GAME 2, VCR, CD, TV)

AUX INPUT (front)

● Audio Outputs

Analog

Pre Out (SUBWOOFER)

Speaker Outputs

FRONT L/R, CENTER, SURROUND L/R

Phones

PHONES (Front, ø 6.3)

● Others

RI REMOTE CONTROL 1

STRM BOX POWER OUT 1 (5 V/1 A)

Specifications and features are subject to change without notice.

Table of display resolutions

Refer to the following table for information about the image formats and resolutions output by this unit in response to input signals.

Input		Output HDMI						
		4K	1080p/24	1080p	1080i	720p	480p/576p	480i/576i
HDMI	4K	○						
	1080p/24		○					
	1080p			○				
	1080i				○			
	720p					○		
	480p/576p						○	
	480i/576i							○
Component	1080p							
	1080i							
	720p							
	480p/576p							
	480i/576i							○
Composite	480i/576i							○

Resolutions supported by HDMI

Input support	Content protection technology	Display resolution	Frame rate	Color space	Color Depth	Remarks	
HDMI input (BD/DVD, CBL/SAT, GAME1, STRM BOX)	HDCP1.4 HDCP2.2	720×480i	60Hz	RGB/YCbCr4:4:4/ YCbCr4:2:2	8/10/12/16bit	With YCbCr4:2:2, Color Depth supported is up to 8/10/12bit.	
		720×576i	50Hz				
		720×480p	60Hz				
		720×576p	50Hz				
		1920×1080i	50/60Hz				
		1280×720p	24/25/30/50/60Hz				
		1680×720p	24/25/30/50/60Hz				
		1920×1080p	24/25/30/50/60Hz				
	2560×1080p	24/25/30/50/60Hz					
	4K (3840×2160p)	24/25/30Hz	RGB/YCbCr4:4:4/ YCbCr4:2:2	8/10/12/16bit	With YCbCr4:2:2, Color Depth supported is up to 8/10/12bit.		
						RGB/YCbCr4:4:4	8bit
							YCbCr4:2:2
		YCbCr4:2:0	8/10/12/16bit				
			4K SMPTE (4096×2160p)	24/25/30Hz	RGB/YCbCr4:4:4/ YCbCr4:2:2	8/10/12/16bit	With YCbCr4:2:2, Color Depth supported is up to 8/10/12bit.
		RGB/YCbCr4:4:4					
50/60Hz				YCbCr4:2:2	8/10/12bit		
	YCbCr4:2:0	8/10/12/16bit					

Precautions

For European Models

Declaration of Conformity

We declare, under our sole responsibility, that this product complies with the standards:

- Safety
- Limits and methods of measurement of radio disturbance characteristics
- Limits for harmonic current emissions
- Limitation of voltage changes, voltage fluctuations and flicker
- RoHS Directive, 2011/65/EU



- Hereby, Onkyo Corporation, declares that this TX-SR343 is in compliance with the essential requirements and other relevant provisions of Directive 1999/5/EC.
- С настоящето, Onkyo Corporation, декларира, че TX-SR343 е в съответствие със съществените изисквания и другитеприложими разпоредби на Директива 1999/5/EC.
- Onkyo Corporation tímto prohlašuje, že TX-SR343 splňuje základní požadavky a všechna příslušná ustanovení Směrnice 1999/5/ES.
- Undertegnede Onkyo Corporation erklærer herved, at følgende udstyr TX-SR343 overholder de væsentlige krav og øvrige relevante krav i direktiv 1999/5/EF.
- Hiermit erklärt Onkyo Corporation, dass sich das Gerät TX-SR343 in Übereinstimmung mit den grundlegenden Anforderungen und den übrigen einschlägigen Bestimmungen der Richtlinie 1999/5/EG befindet.
- Käesolevaga kinnitab Onkyo Corporation seadme TX-SR343 vastavust direktiivi 1999/5/EÜ põhinõuetele ja nimetatud direktiivist tulenevatele teistele asjakohastele sätetele.
- ΜΕ ΤΗΝ ΠΑΡΟΥΣΑ Ο ΚΑΤΑΣΚΕΥΑΣΤΗΣ Onkyo Corporation ΔΗΛΩΝΕΙ ΟΤΙ ΤΟ TX-SR343 ΣΥΜΜΟΡΦΩΝΕΤΑΙ ΠΡΟΣ ΤΙΣ ΟΥΣΙΩΔΕΙΣ ΑΠΑΙΤΗΣΕΙΣ ΚΑΙ ΤΙΣ ΛΟΙΠΕΣ ΣΧΕΤΙΚΕΣ ΔΙΑΤΑΞΕΙΣ ΤΗΣ ΟΔΗΓΙΑΣ 1999/5/ΕΚ
- Por la presente, Onkyo Corporation, declara que este TX-SR343 cumple con los requisitos esenciales y otras exigencias relevantes de la Directiva 1999/5/EC.
- Par la présente, Onkyo Corporation déclare que l'appareil TX-SR343 est conforme aux exigences essentielles et aux autres dispositions pertinentes de la directive 1999/5/CE.
- Con la presente Onkyo Corporation dichiara che questo TX-SR343 è conforme ai requisiti essenziali ed alle altre disposizioni pertinenti stabilite dalla direttiva 1999/5/CE.
- Ar šo Onkyo Corporation deklarē, ka TX-SR343 atbilst Direktīvas 1999/5/EK būtiskajām prasībām un citiem ar to saistītajiem noteikumiem.
- Šiuo Onkyo Corporation deklaruoja, kad šis TX-SR343 atitinka esminius reikalavimus ir kitas 1999/5/EB Direktyvos nuostatas.
- A Onkyo Corporation ezzennel kijelenti, hogy a TX-SR343 típusú berendezés teljesíti az alapvető követelményeket és más 1999/5/EK irányelvben meghatározott vonatkozó rendelkezéseket.
- Hierbij verklaart Onkyo Corporation dat het toestel l TX-SR343 in overeenstemming is met de essentiële eisen en de andere relevante bepalingen van richtlijn 1999/5/EG.
- Niniejszym Onkyo Corporation deklaruje że TX-SR343 jest zgodny z zasadniczymi wymaganiami i innymi właściwymi postanowieniami Dyrektywy 1999/5/EC.
- Eu, Onkyo Corporation, declaro que o TX-SR343 cumpre os requisitos essenciais e outras provisões relevantes da Directiva 1999/5/EC.

- Prin prezenta, Onkyo Corporation, declară că aparatul TX-SR343 este în conformitate cu cerințele esențiale și cu alte prevederi pertinente ale Directivei 1999/5/CE.
- Onkyo Corporation tímto vyhlasuje, že TX-SR343 a splňa základné požiadavky a všetky príslušné ustanovenia Smernice 1999/5/ES.
- Onkyo Corporation izjavlja, da je ta TX-SR343 v skladu z bistvenimi zahtevami in drugimi relevantnimi določili direktive 1999/5/ES.
- Onkyo Corporation vakuuttaa täten että TX-SR343 tyyppinen laite on direktiivin 1999/5/EY oleellisten vaatimusten ja sitä koskevien direktiivien muiden ehtojen mukainen.
- Härmed förklarar Onkyo Corporation att denna TX-SR343 följer de väsentliga kraven och andra relevanta stadgar i Direktiv 1999/5/EC.
- Hér með lýsir Onkyo Corporation því yfir að varan TX-SR343 er í samræmi við grunnkröfur og aðrar kröfur sem gerðar eru í tilskipun 1999/5/EC.
- Onkyo Corporation erklærer herved at denne TX-SR343 er i overensstemmelse med vesentlige krav og andre relevante bestemmelser i direktiv 1999/5/EC.
- Ovime Onkyo Corporation, potvrđuje da je TX-SR343 u suglasnosti sa osnovnim zahtjevima i ostalim relevantnim odredbama Direktive 1999/5/EC.

License and Trademark Information



Manufactured under license from Dolby Laboratories. Dolby, Pro Logic and the double-D symbol are trademarks of Dolby Laboratories.



For DTS patents, see <http://patents.dts.com>. Manufactured under license from DTS Licensing Limited. DTS, DTS-HD, the Symbol, & DTS and the Symbol together are registered trademarks of DTS, Inc. © DTS, Inc. All Rights Reserved.



"CINEMA FILTER" and "CINEMA FILTER (logo)" are trademarks of Onkyo Corporation.



The terms HDMI and HDMI High-Definition Multimedia Interface, and the HDMI Logo are trademarks or registered trademarks of HDMI Licensing LLC in the United States and other countries.



The Bluetooth® word mark and logos are registered trademarks owned by Bluetooth SIG, Inc. and any use of such marks by Onkyo is under license. Other trademarks and trade names are those of their respective owners. Onkyo does not guarantee Bluetooth compatibility between the AV receiver and all Bluetooth-enabled devices. For compatibility between the AV receiver and another device with Bluetooth technology, consult the device's documentation and dealer. In some countries, there may be restrictions on using Bluetooth devices. Check with your local authorities.

Apple, iPod and iPhone are trademarks of Apple Inc., registered in the U.S. and other countries.

Apple TV is a trademark of Apple Inc., registered in the U.S. and other countries.

QR Code is a registered trademark of DENSO WAVE INCORPORATED.





"x.v.Color" is a trademark of Sony Corporation.

Music Optimizer, RIHD and WRAT are trademarks of Onkyo Corporation.

"RIHD" and "RIHD (logo)" are trademarks of Onkyo Corporation.

"All other trademarks are the property of their respective owners."

Supplied Accessories

-  Indoor FM antenna --- (1)
-  AM loop antenna --- (1)
-  Remote controller (RC-897M) --- (1)
Batteries (AA/R6) --- (2)
-  Power cord (Taiwanese models) --- (1)

* The number in parenthesis indicates the quantity. On packaging, the letter at the end of the product name indicates the color.

How to use the remote controller

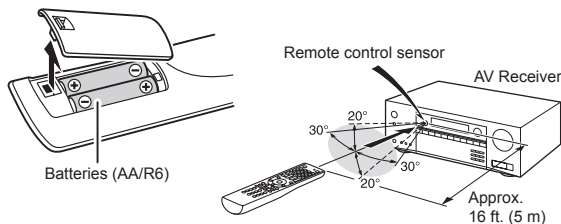

- * If you do not use the remote controller for a long time, remove the batteries to prevent leakage.
- * Note that keeping consumed batteries inside may cause corrosion resulting in damage of the remote controller.

ONKYO

Onkyo Corporation
Kitahama Chuo Bldg, 2-2-22 Kitahama, Chuo-ku,
OSAKA 541-0041, JAPAN
<http://www.onkyo.com/>

The Americas

Onkyo U.S.A. Corporation
18 Park Way, Upper Saddle River, N.J. 07458, U.S.A.
For Dealer, Service, Order and all other Business Inquiries:
Tel: 201-785-2600 Fax: 201-785-2650
<http://www.us.onkyo.com/>

For Product Support Team Only:
1-800-229-1687
<http://www.us.onkyo.com/>

Europe

Onkyo Europe Electronics GmbH
Liegnitzerstrasse 6, 82194 Groebenzell, GERMANY
Tel: +49-8142-4401-0 Fax: +49-8142-4208-213
<http://www.eu.onkyo.com/>

Onkyo Europe Electronics GmbH (UK Branch)

Meriden House, Ground floor, 69 - 71 Clarendon Road,
Watford, Hertfordshire, WD17 1DS, United Kingdom
Tel: +44 (0)8712-00-19-96 Fax: +44 (0)8712-00-19-95

China

Onkyo China Limited (Hong Kong)
Unit 1033, 10/F, Star House, No 3, Salisbury Road,
Tsim Sha Tsui Kowloon, Hong Kong.
Tel: 852-2429-3118 Fax: 852-2428-9039
<http://www.hk.onkyo.com/>

Onkyo China PRC (Mainland)

1301, 555 Tower, No.555 West NanJing Road, Jing'an District,
Shanghai, China 200041,
Tel: 86-21-52131366 Fax: 86-21-52130396
<http://www.cn.onkyo.com/>

Asia, Oceania, Middle East, Africa

Please contact an Onkyo distributor referring to Onkyo
SUPPORT site.
<http://www.intl.onkyo.com/support/>

The above-mentioned information is subject to change
without prior notice.
Visit the Onkyo web site for the latest update.

SN 29401958A

(C) Copyright 2015 Onkyo Corporation Japan. All rights reserved. Onkyo has the Privacy Policy. You can review it at [<http://www.onkyo.com/privacy/>].



* 2 9 4 0 1 9 5 8 A *

F1504-1